

Product assortment

Max Frank Nederland B.V.



BUILDING COMMON GROUND

Individuele project oplossingen en producten van MAX FRANK zijn te vinden in een breed scala van bouwwerken zoals: hoogbouw, bruggen, tunnels of infrastructuur. Sinds de oprichting heeft MAX FRANK zich ontwikkeld tot een geïntegreerde leverancier van bouwtechnologie. We begeleiden onze klanten door middel van een zeer technische en intensieve aaneenschakeling van industriële producties, hoogwaardige producten en veelzijdige diensten. MAX FRANK ondersteunt zijn klanten op betrouwbare wijze in alle fasen van de bouw.

Toegevoegde waarde voor onze partners wordt gegenereerd door onze know-how, die voortkomt uit meer dan 50 jaar ervaring, een verscheidenheid aan bewezen en innovatieve producten voor de staal betonbouw en het technologisch spectrum van onze productgroepen: afstandhouders, bekistingstechnologie, wapeningstechnologie, afdichtingstechniek en bouwakoestiek.

Door zijn uitgesproken gevoel voor waarden en zijn betrouwbare integriteit, weet MAX FRANK hoe kloven overbrugd moeten worden en hoe verschillende partijen voor een gemeenschappelijke agenda overtuigd kunnen worden. Het vermogen om aandachtig te luisteren en de juiste vragen te stellen helpt. Vragen die tot de kern van de taak doordringen, helpen om nieuwe inzichten te verwerven en meer en meer een algemene gemeenschappelijke basis bepalen.

Wij bij MAX FRANK noemen dat:

BUILDING COMMON GROUND

INDIVIDUELE DIVERSITEIT

De producten van MAX FRANK zijn technisch geavanceerd, vereisen uitgebreide uitleg en advies. Maar zijn vooral veelzijdig in gebruik en geven een breed scala aan voordelen. Onze service is veelzijdig en juist om die reden zeer persoonlijk.



Het brede scala aan bewezen producten en de technologische bandbreedte van de diverse divisies stellen ons in staat om klant specifieke oplossingen en voordelen te ontwikkelen samen met planners, bouwbedrijven en/of eigenaren van gebouwen. En om bouwwerken te plannen die duurzaam, veilig, dicht en stil zijn.

Met onze services bieden wij u ondersteuning vanaf de planningsfase tot na de voltooiing. Samen met onze partners creëren we individuele, uitgebreide en kosteneffectieve project oplossingen.

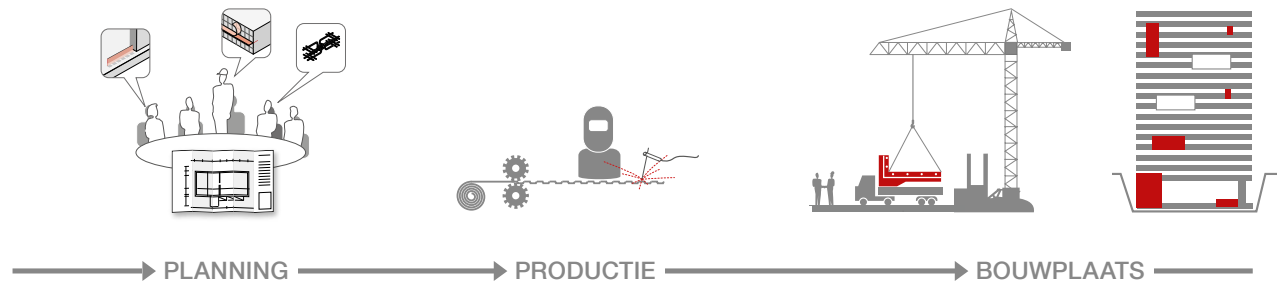

ONZE KRACHT

Een breed assortiment, hoogwaardige product combinaties, project oplossingen, afstemming van planning, productie en verkoop.



VOORDELEN VOOR DE KLANT

Kosten- en tijdsbesparing, oplossing vanuit één bron.



DE GEMEENSCHAPPELIJKE AANPAK

Duurzame en veilige bouwwerken.

BEZOEK ONZE WEBSITE

www.maxfrank.com

Met het gebruiksvriendelijke webontwerp kunt u door de MAX FRANK-website navigeren en is de inhoud gemakkelijk toegankelijk.

Naast informatie over onze producten biedt de website ook onze diverse diensten. Praktische toepassingen kunnen er gevonden worden die ondersteuning bieden in alle stadia van de bouw.



MAX FRANK BUILDINGS

Deze tool is geïntegreerd in de website en gekoppeld aan de gedetailleerde productinformatie.

Het virtuele landschap biedt u de meest optimale producten voor het type bouwwerk: station, brug, kantoorgebouw, wolkenkrabber, rioolwaterzuiveringsinstallatie, museum, drinkwatertank, tunnel, waterkrachtcentrale en woningbouw.



PRODUCTZOEKER

Filter eenvoudig aan de hand van de relevante toepassingsgebieden en producteigenschappen en u vindt het ideale product voor uw vereisten.



STRUCTUUR VAN DE PRODUCTPAGINA'S

Voor een beter overzicht van alle productinformatie en documenten, treft u alle details op één pagina: de voordelen voor u als klant, productvarianten, systeemoplossingen, documenten en referentieprojecten.



Afstandhouders

6



Bekistingstechniek

10

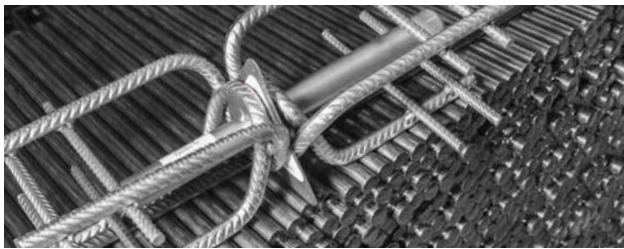

Wapeningstechniek

36



Afdichtingstechniek

46



Bouwakoestiek

60

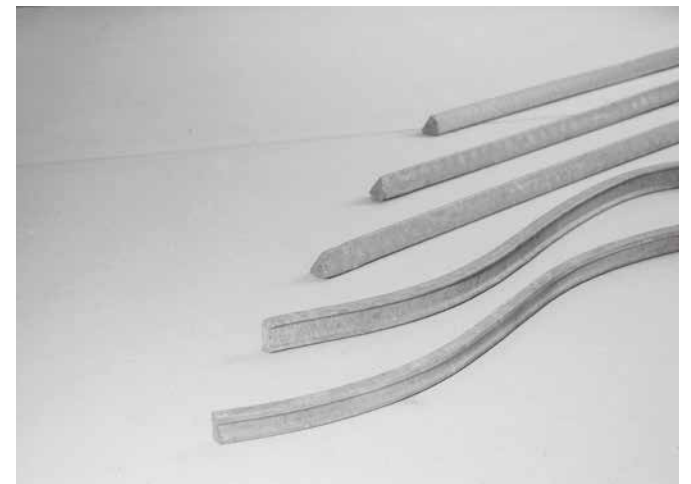
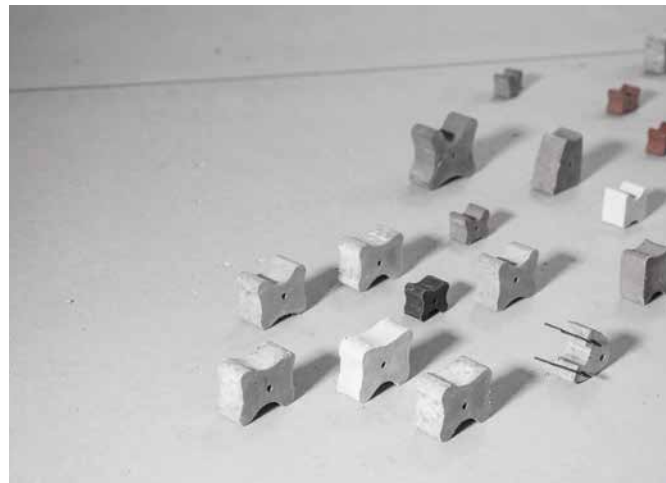
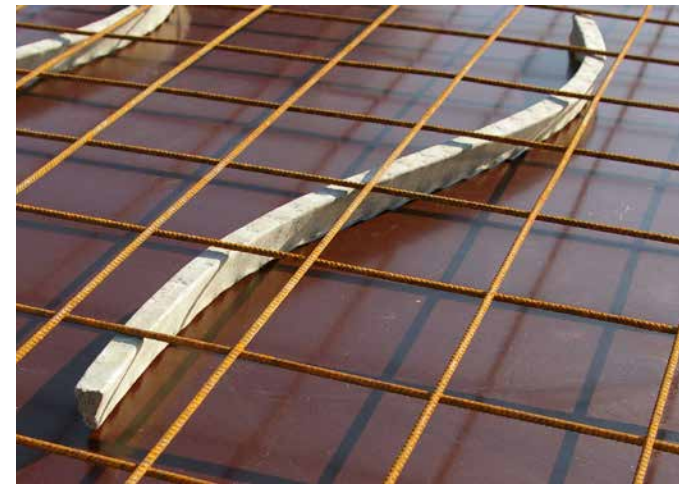
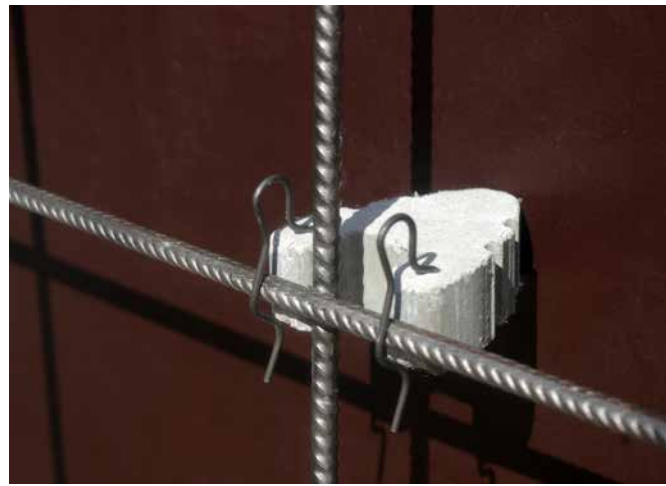

Afstandhouders van vezelbeton

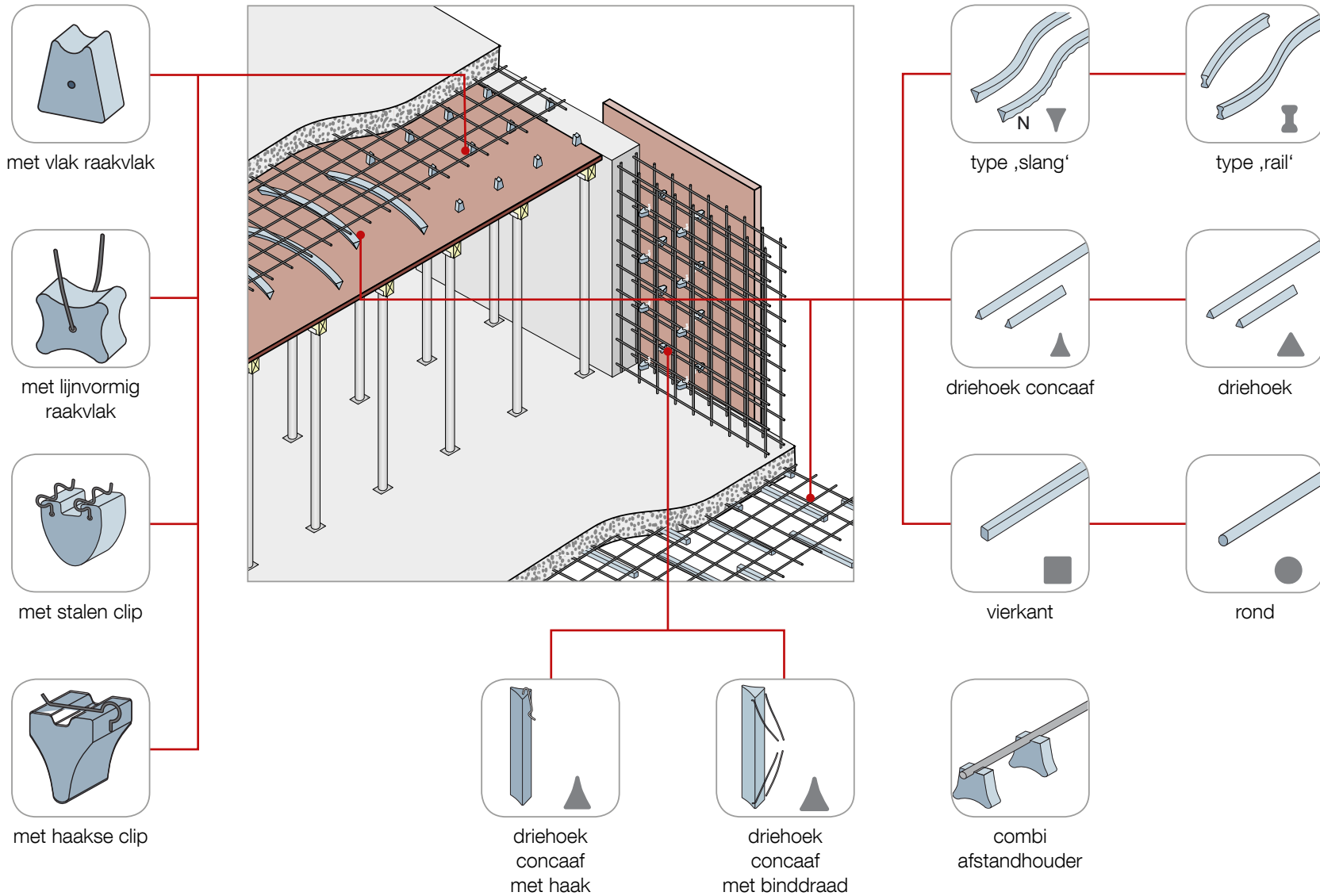

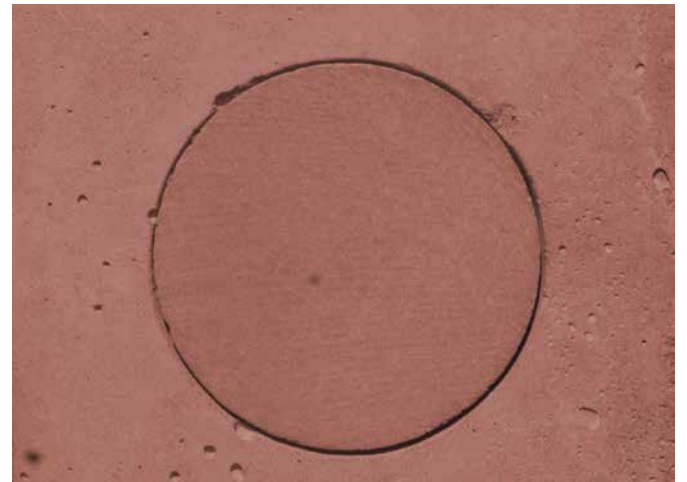

Bekistingsafstandhouder vezelbetonbuis

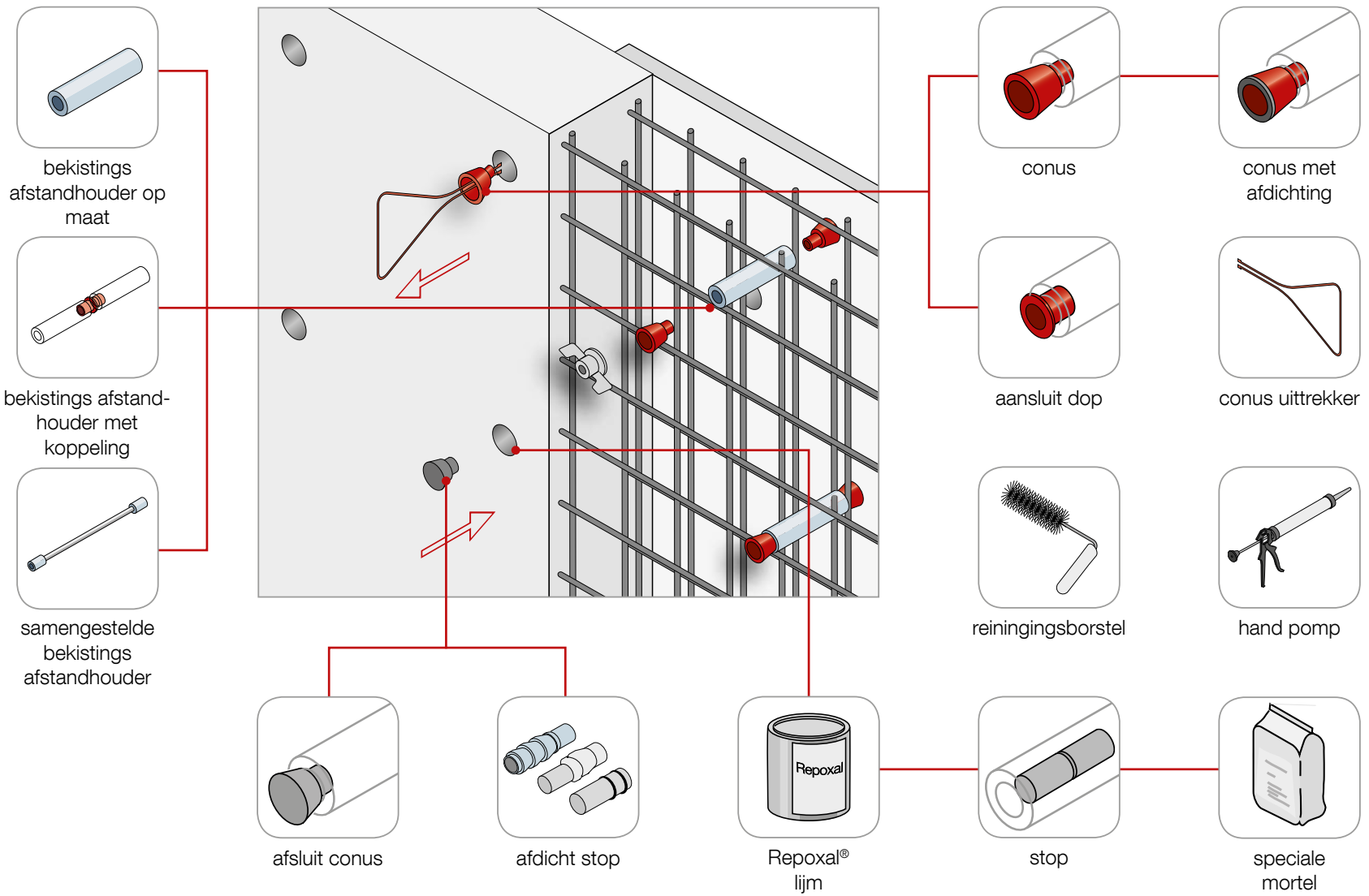

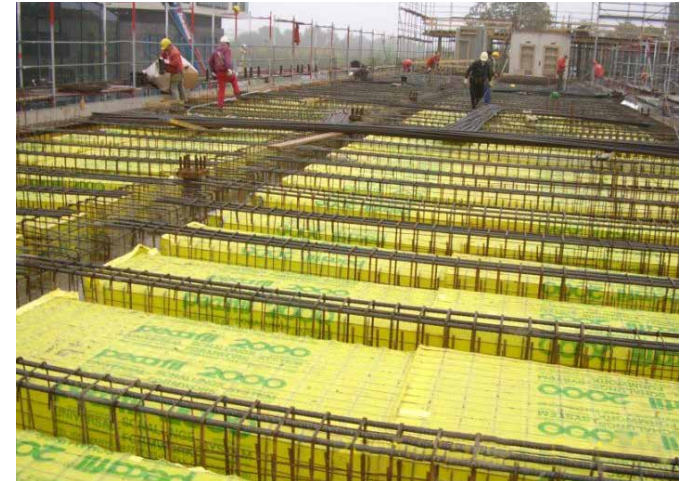
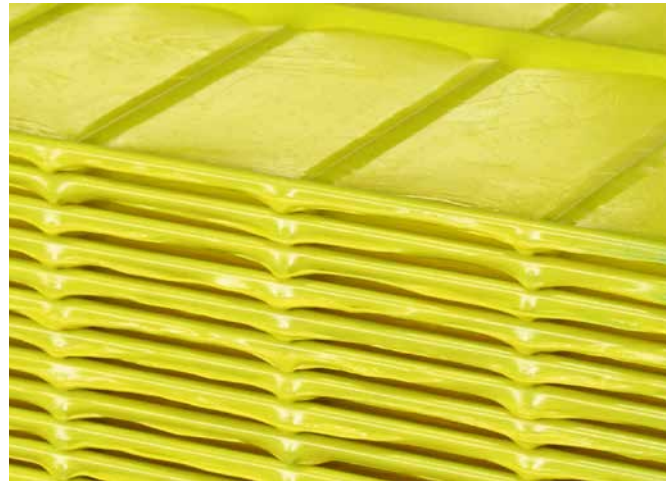

Pecafil® universele bekisting

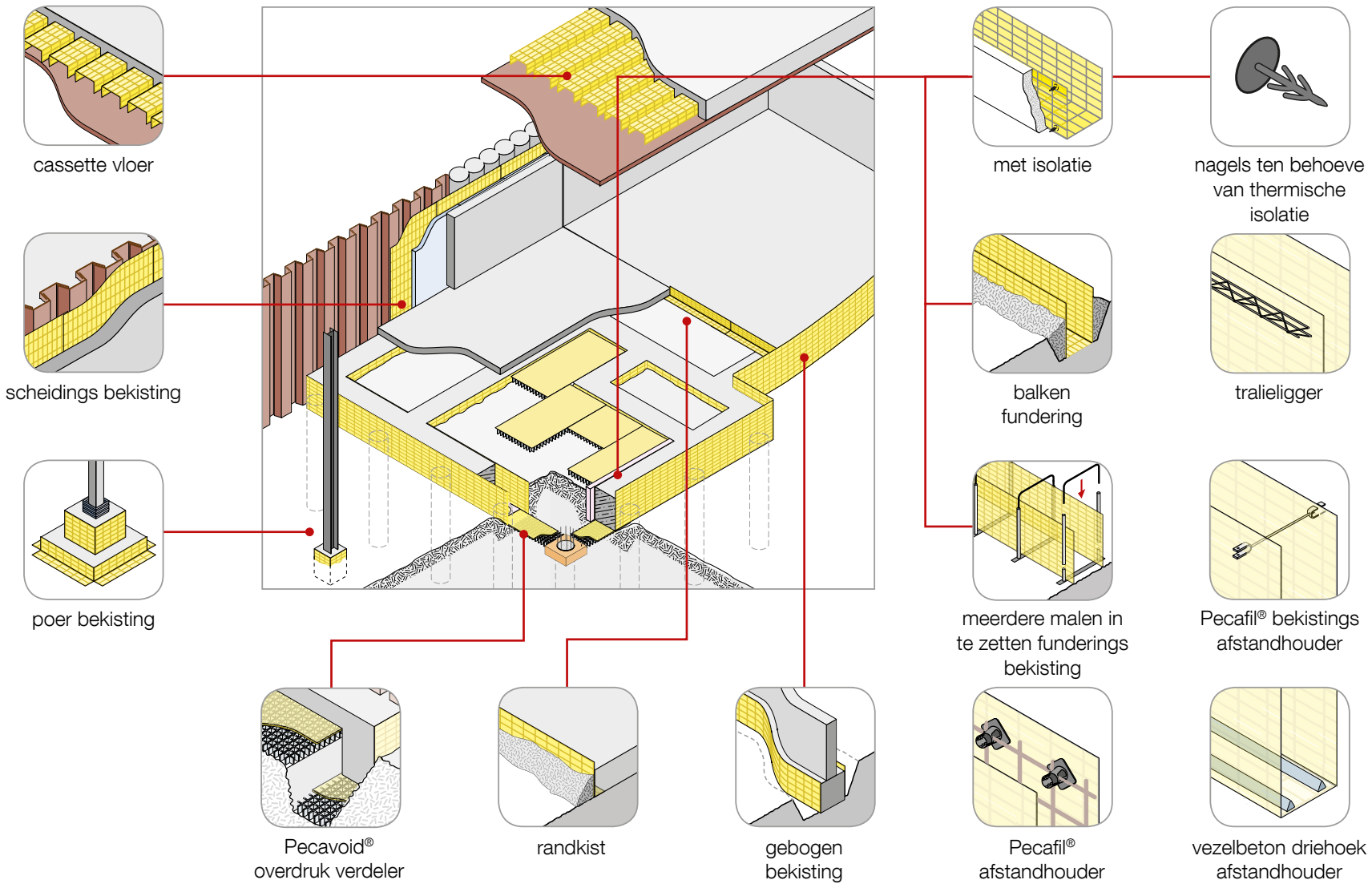



Pecafil[®] doorwerk beplating



Varianten

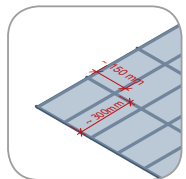

standaard

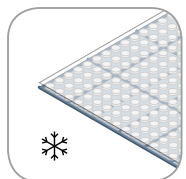

uitgevoerd met
genopte folie

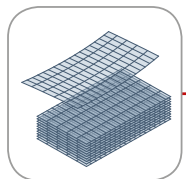

plaat materiaal

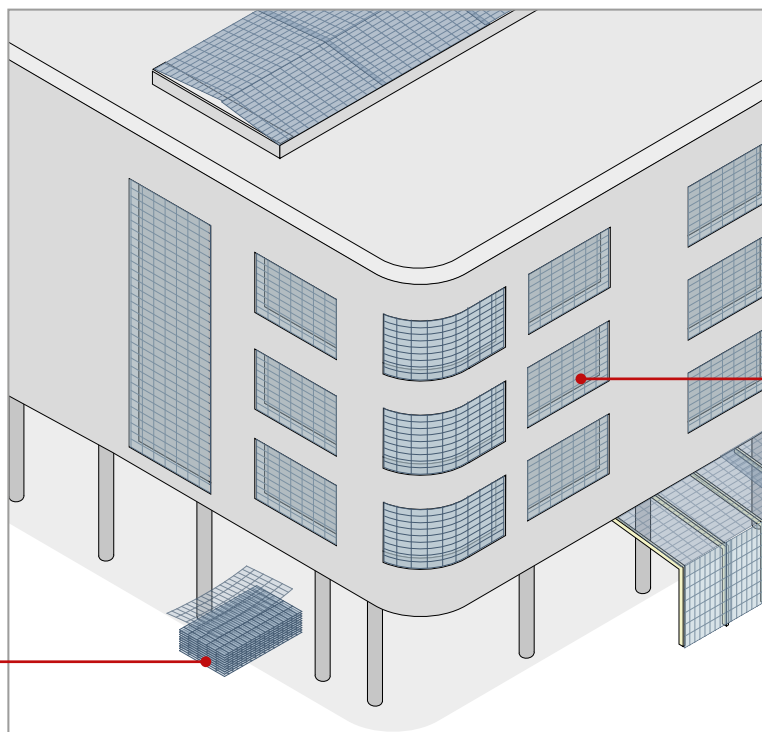

Bewerkt

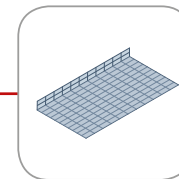

eenzijdig gebogen

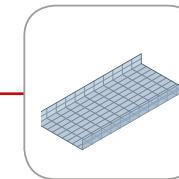

twee zijdig gebogen

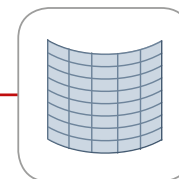

prefab
gebogen

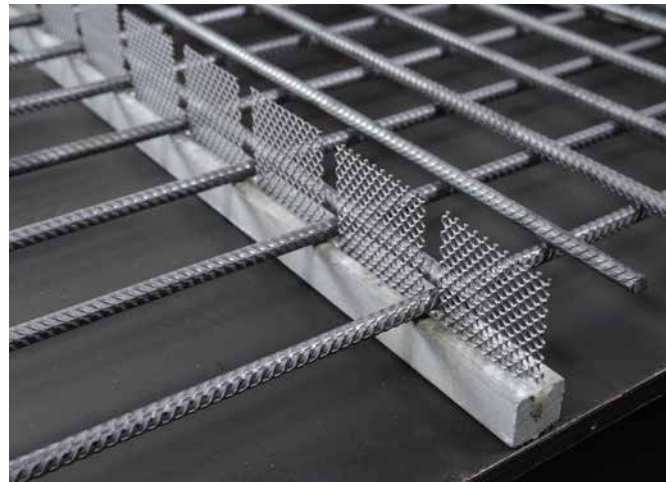

Stremaform® bekisting voor stortonderbreking

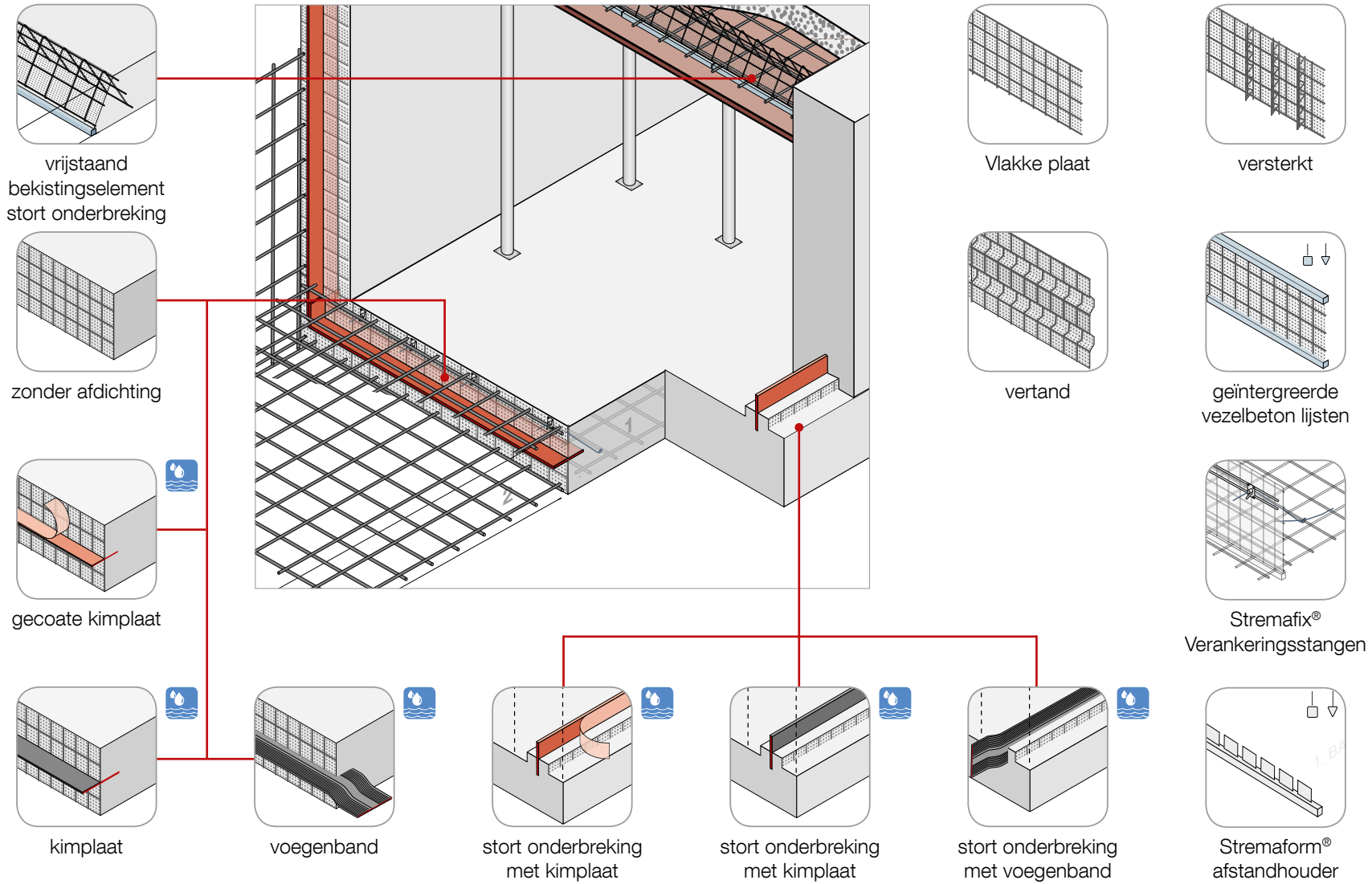

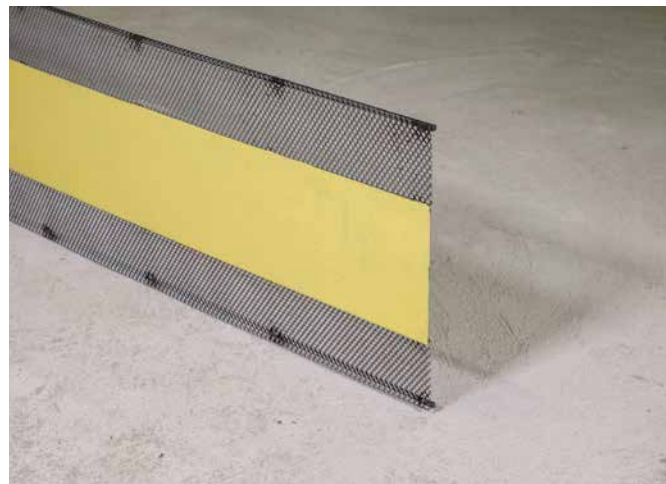

Stremaform[®] bekistings element voor scheur inleider

bekistingselement voor scheur inleider

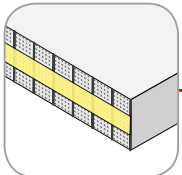

zonder afdichting

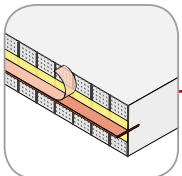

met gecoate kimplaat

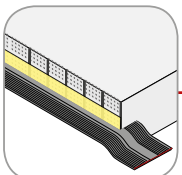

met voegenband

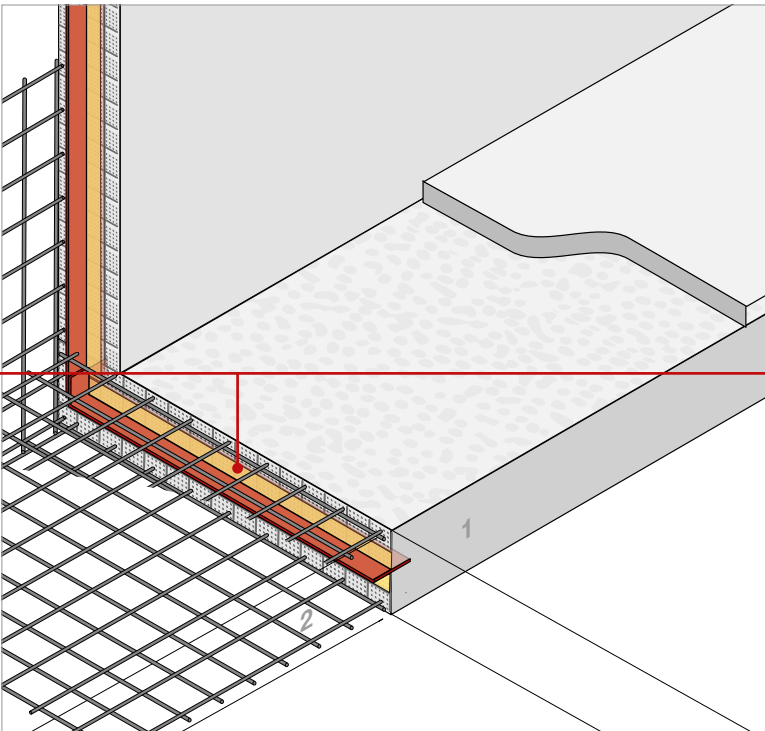

scheur inleider element

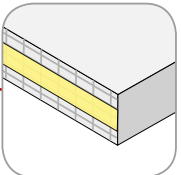

zonder afdichting

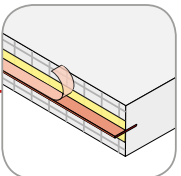

met gecoate kimplaat



Stremaform® bekistings element voor dilatatie



geluid isolerende
voeg vulling

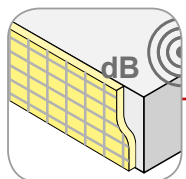

geluid isolerende
voegvulling

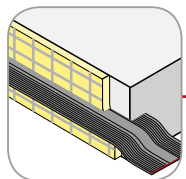

met voegenband

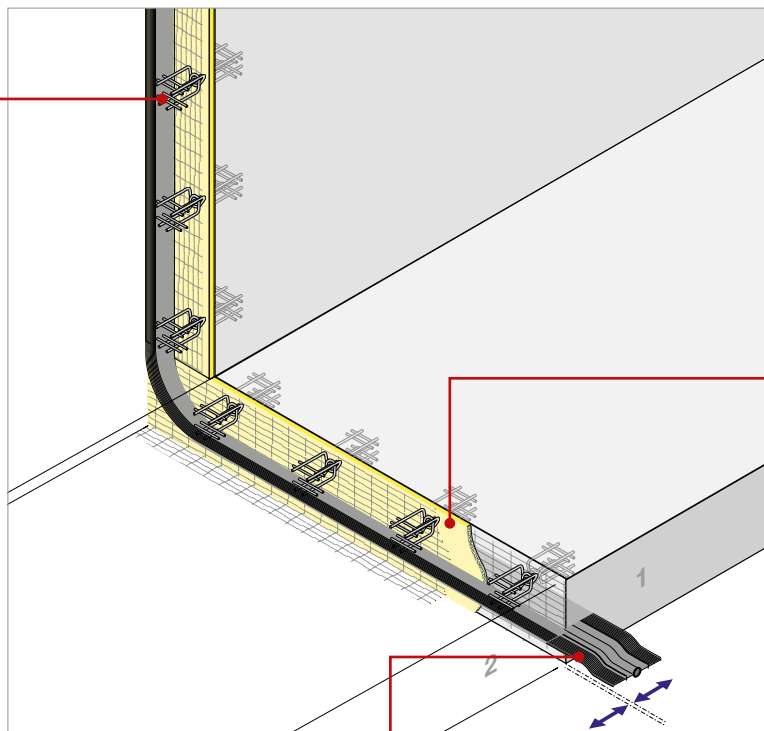

voegvulling

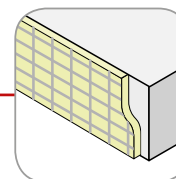

zonder afdichting

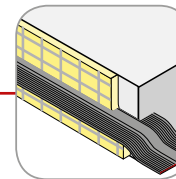

met voegenband

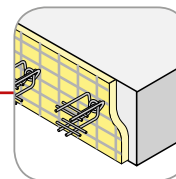

met dwarskracht
overdracht

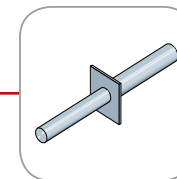

met Egcodübel®
deuvels

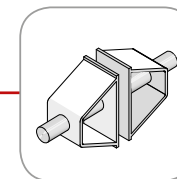

met Egcodorn®
DND deuvels voor
dynamische belasting

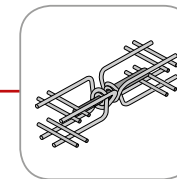

met Egcodorn®
deuvels voor
statische belasting

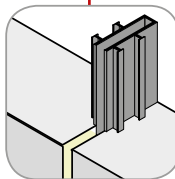

afdichtende
voegenband

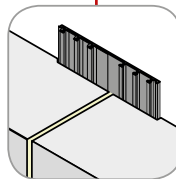

uitwendige
voegenband

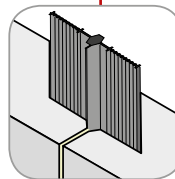

inwendige
voegenband



Splitboard® stortonderbreking voor scheidingsvoegen



bekistings element voor voeg



Splitboard® standaard

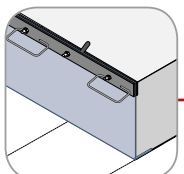

Splitboard® met randkist

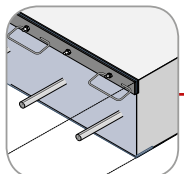

Splitboard® met dwarskracht overdracht

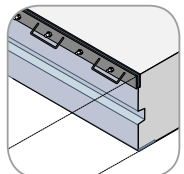

bijkomende vertanding

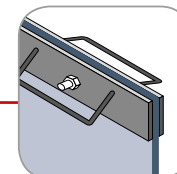
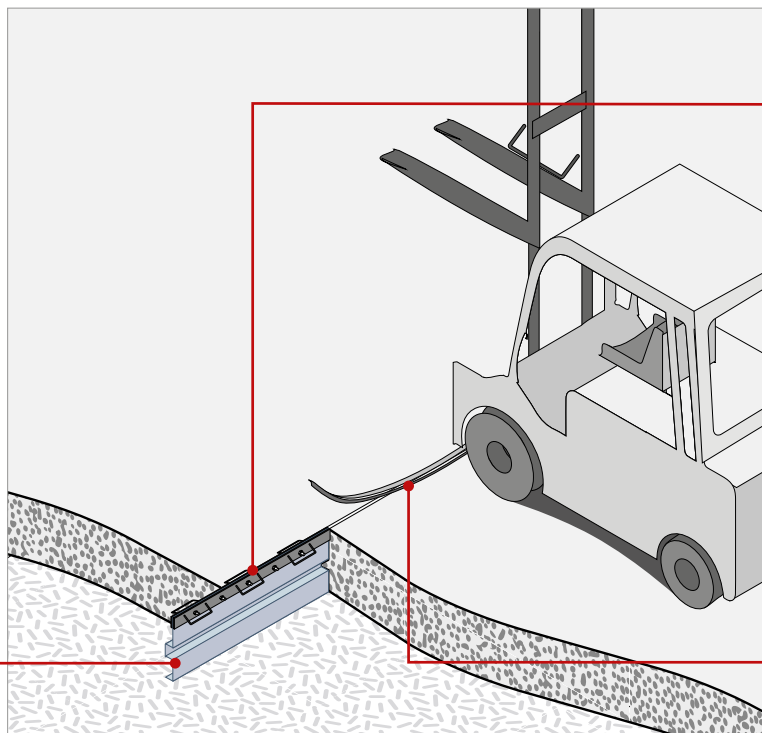

randkist met staalsrip

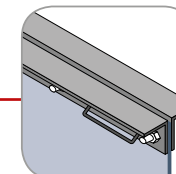

randkist met hoekstaal

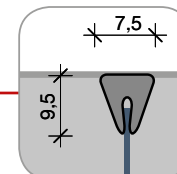

pvc profiel 1 demonteerbaar

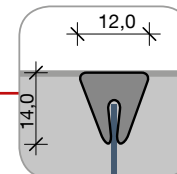

pvc profiel 2 demonteerbaar

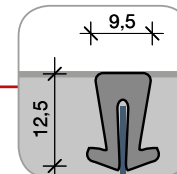

pvc profiel 3 permanent



Tubbox® Multi voor meerdere inzetten





Tubbox® kolom bekisting





Fratec® vorm bekisting

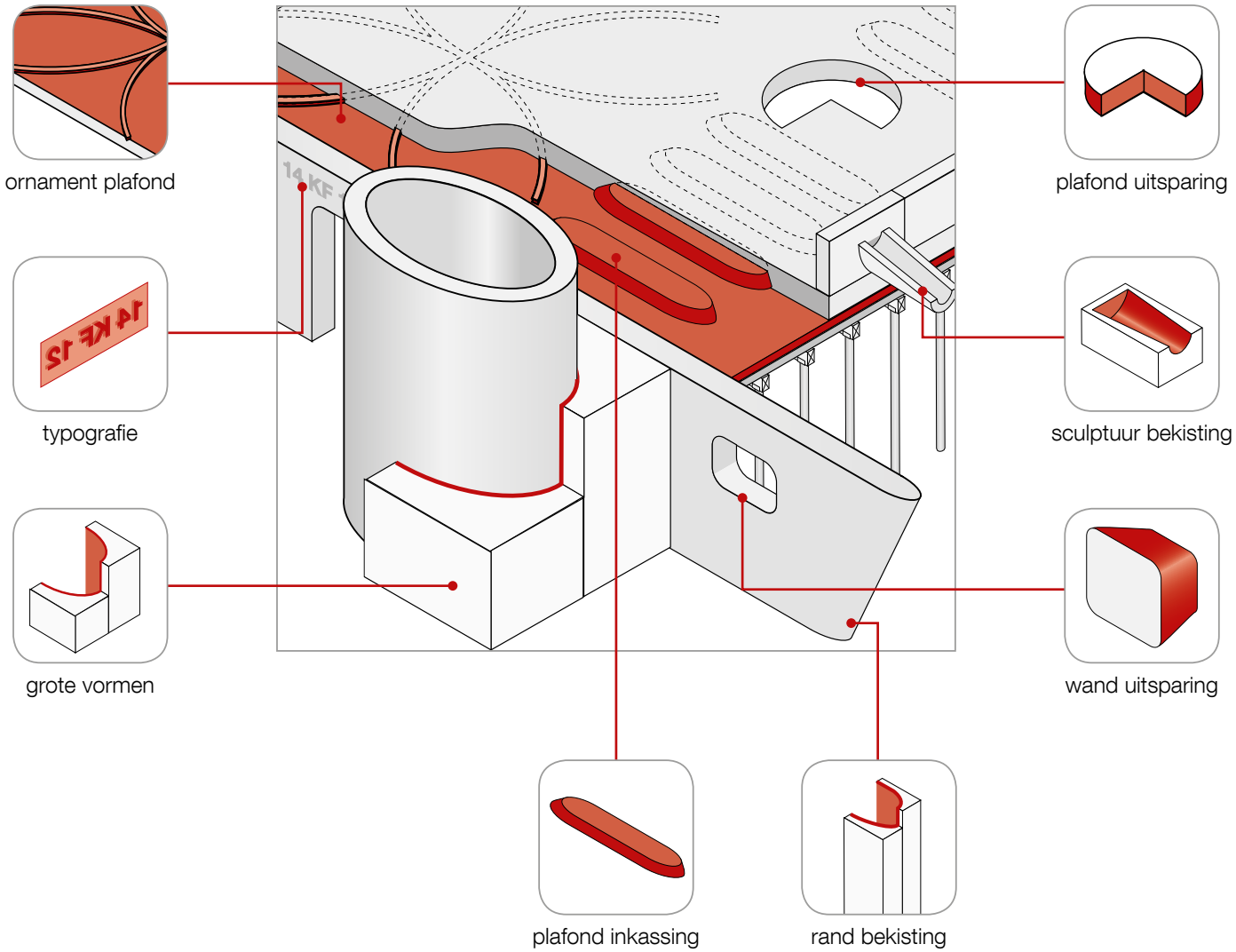



Zemdrain® bekistingsfolie

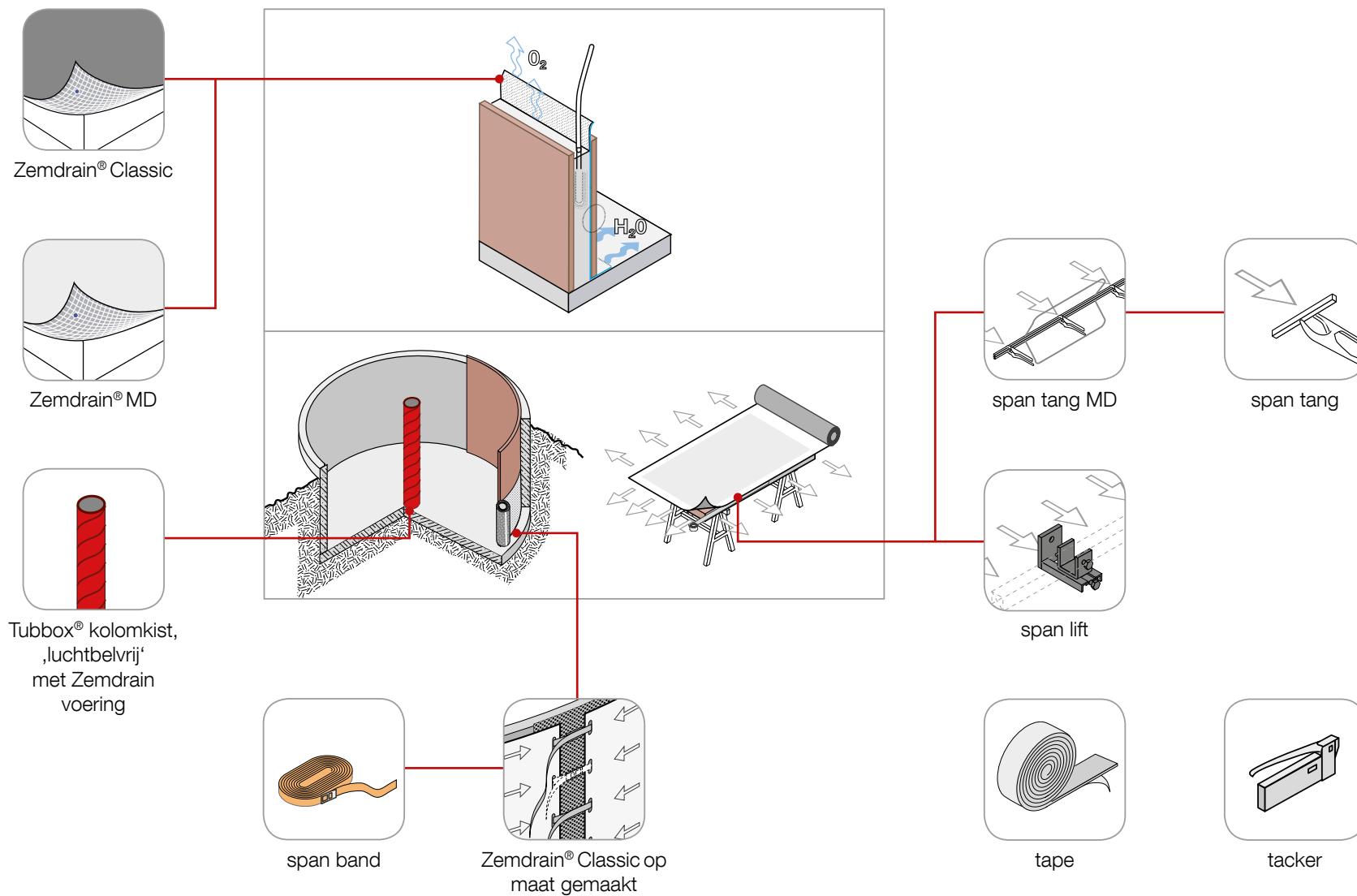

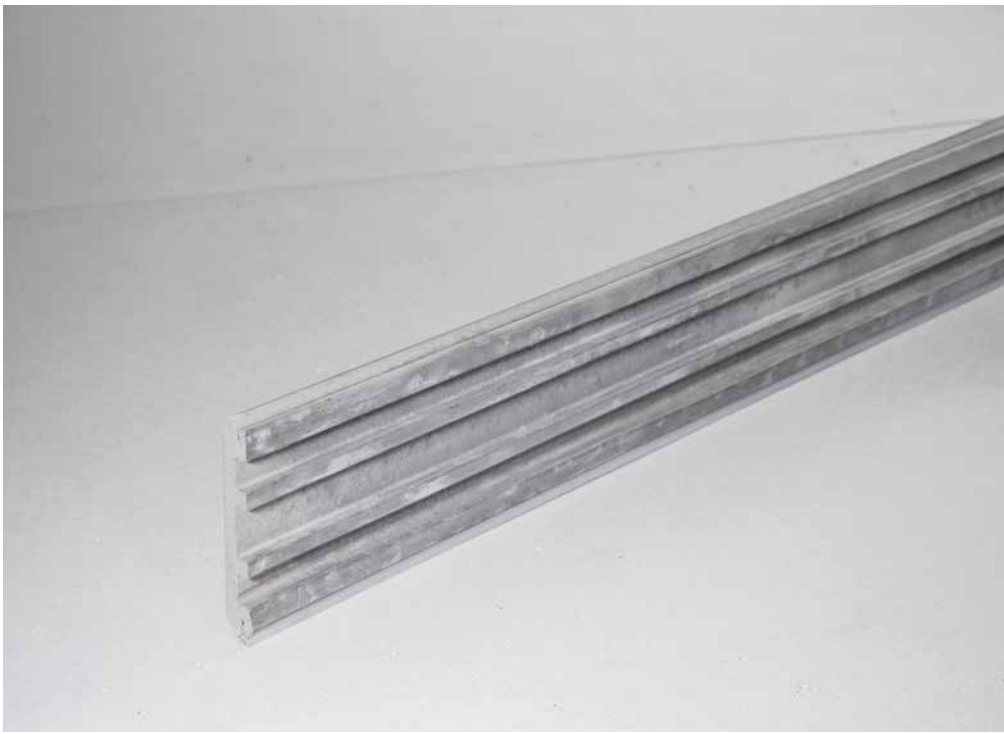

Bekisting van balkons en vloerplaten

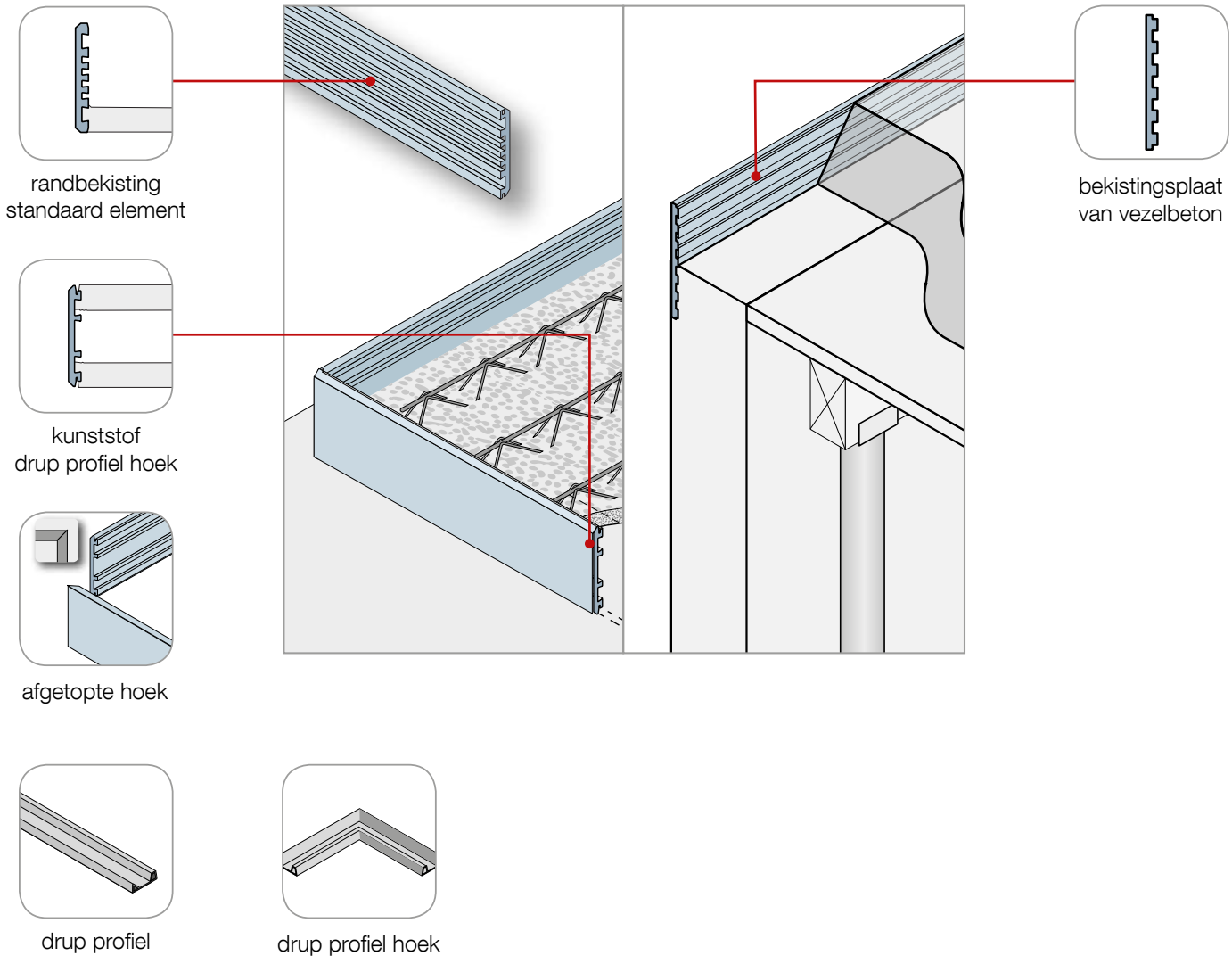

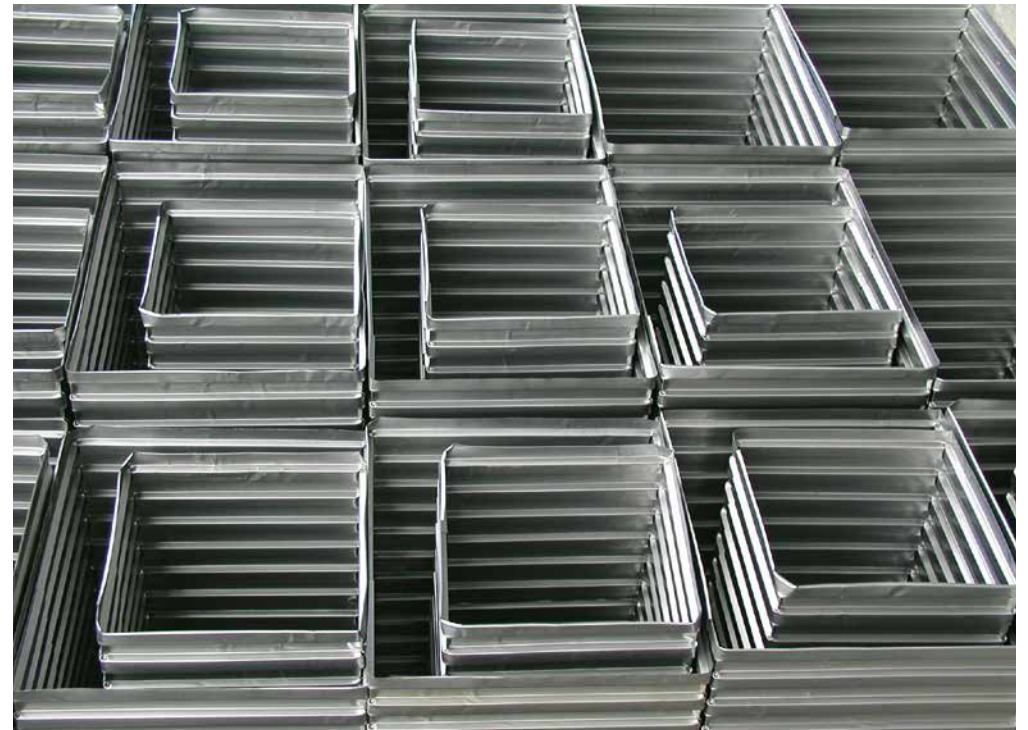

Poer en uitsparing

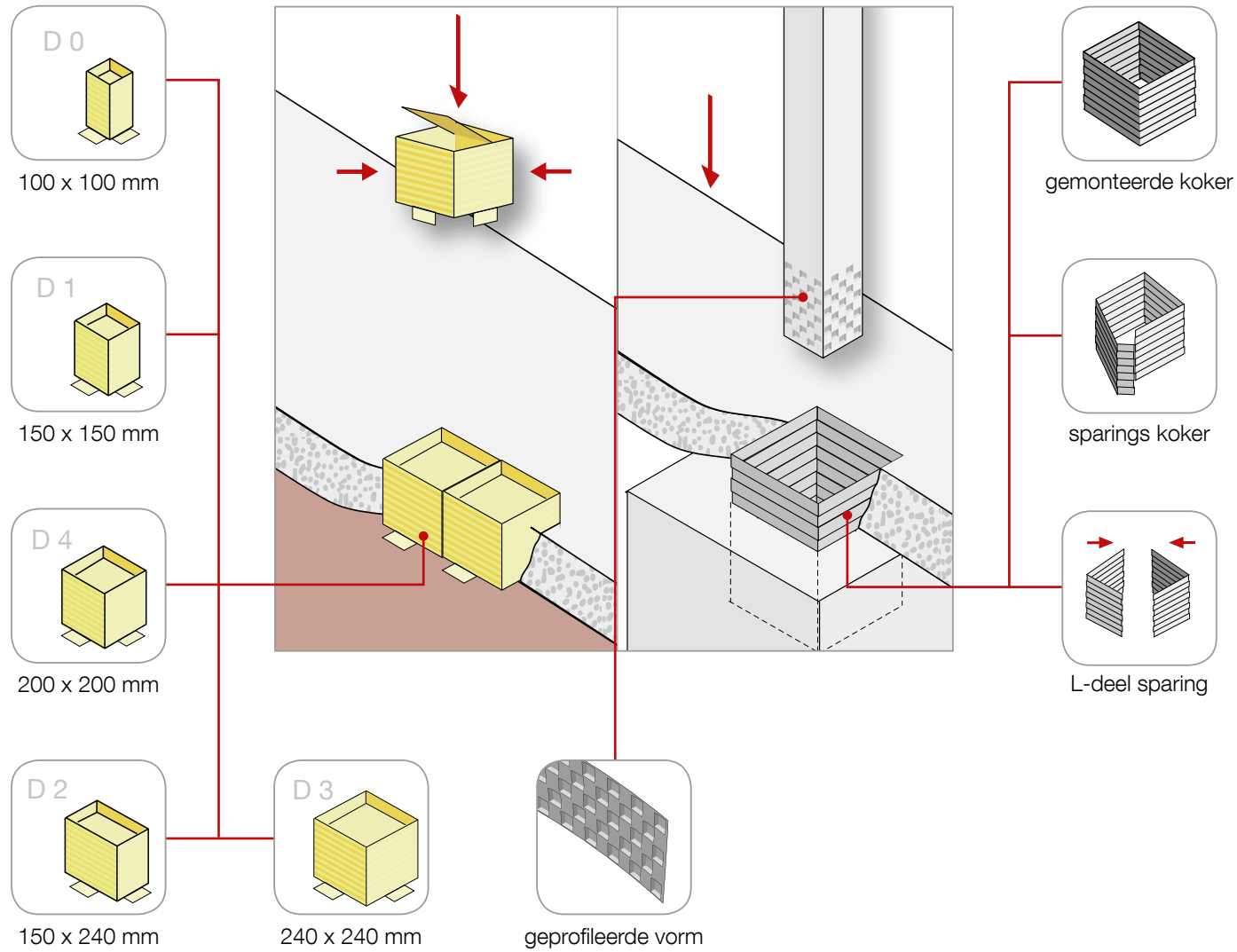



Trennfit ontkistingsmiddel

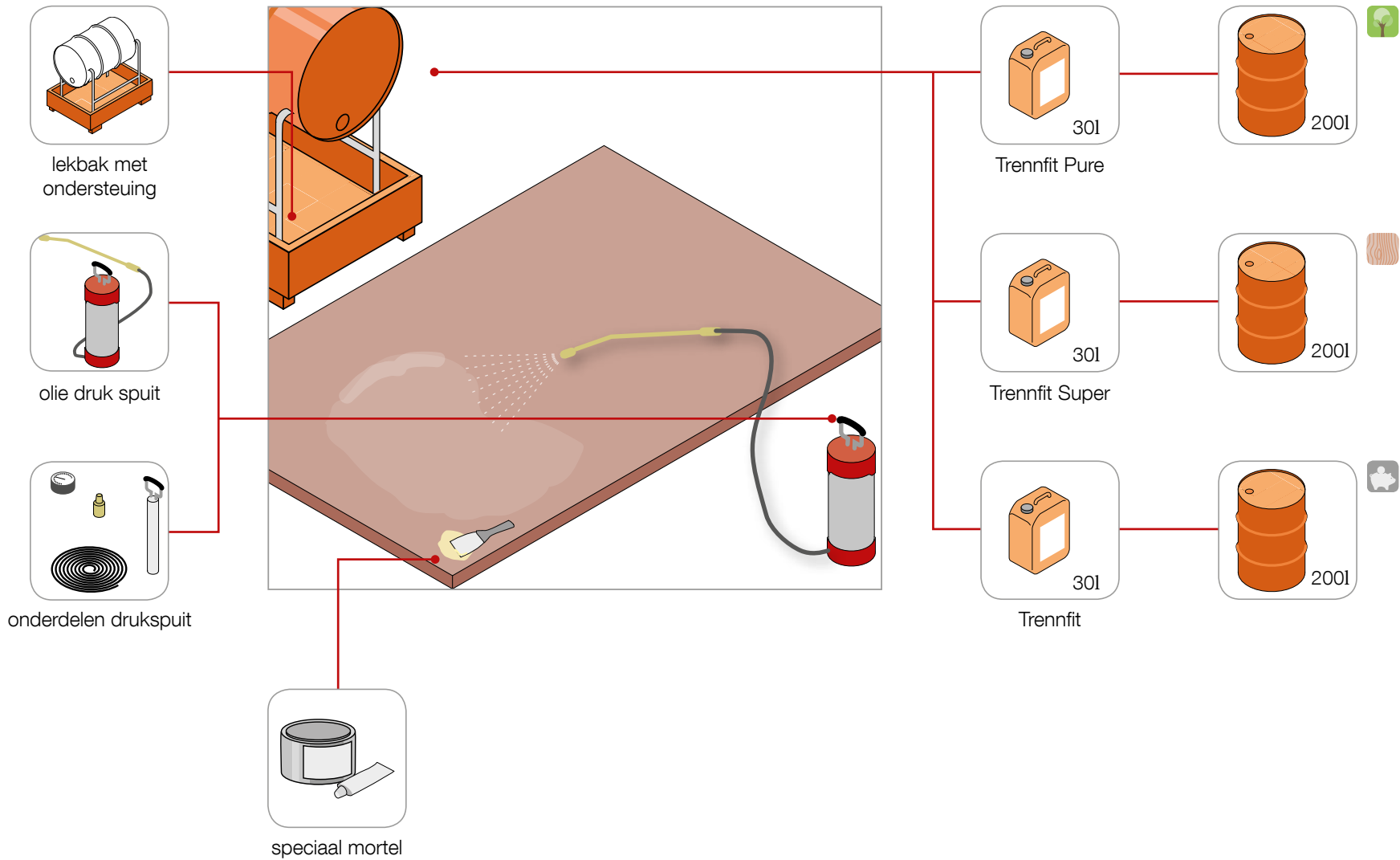

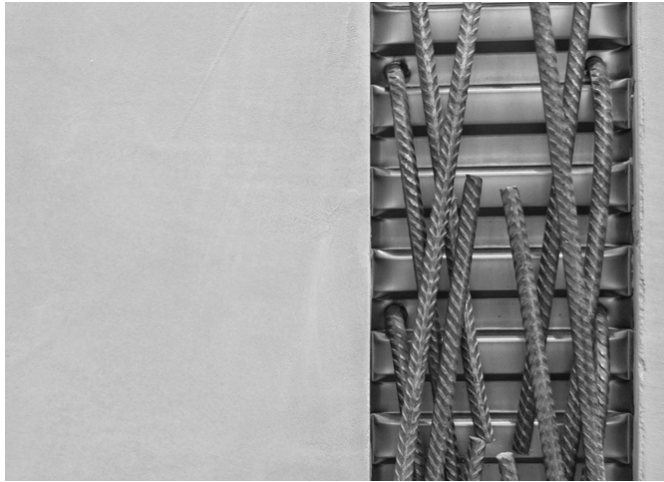
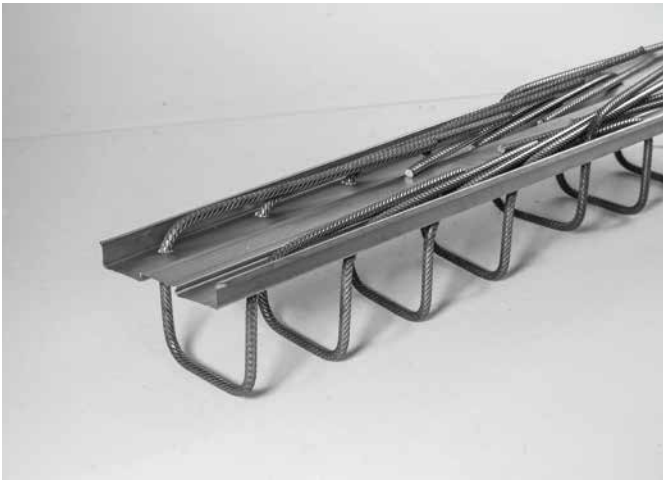

Stabox® stekkenbak

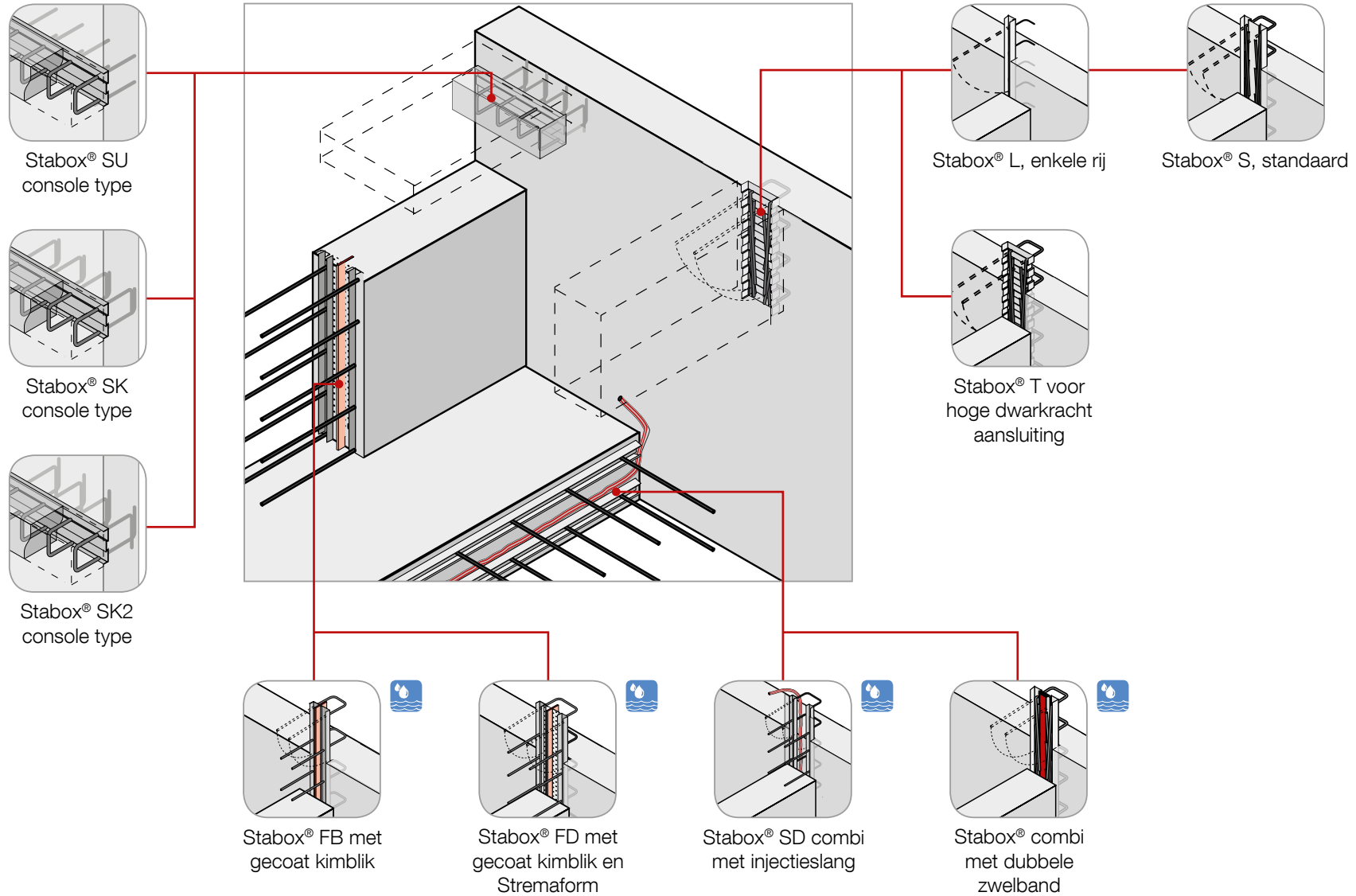

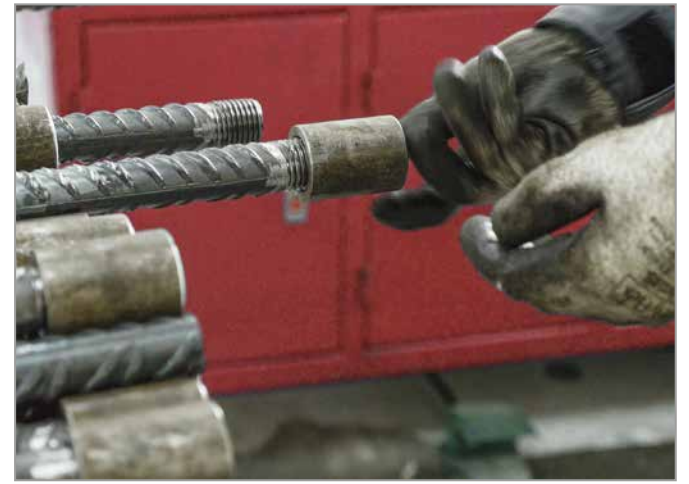

Coupler wapenings doorkoppel systeem

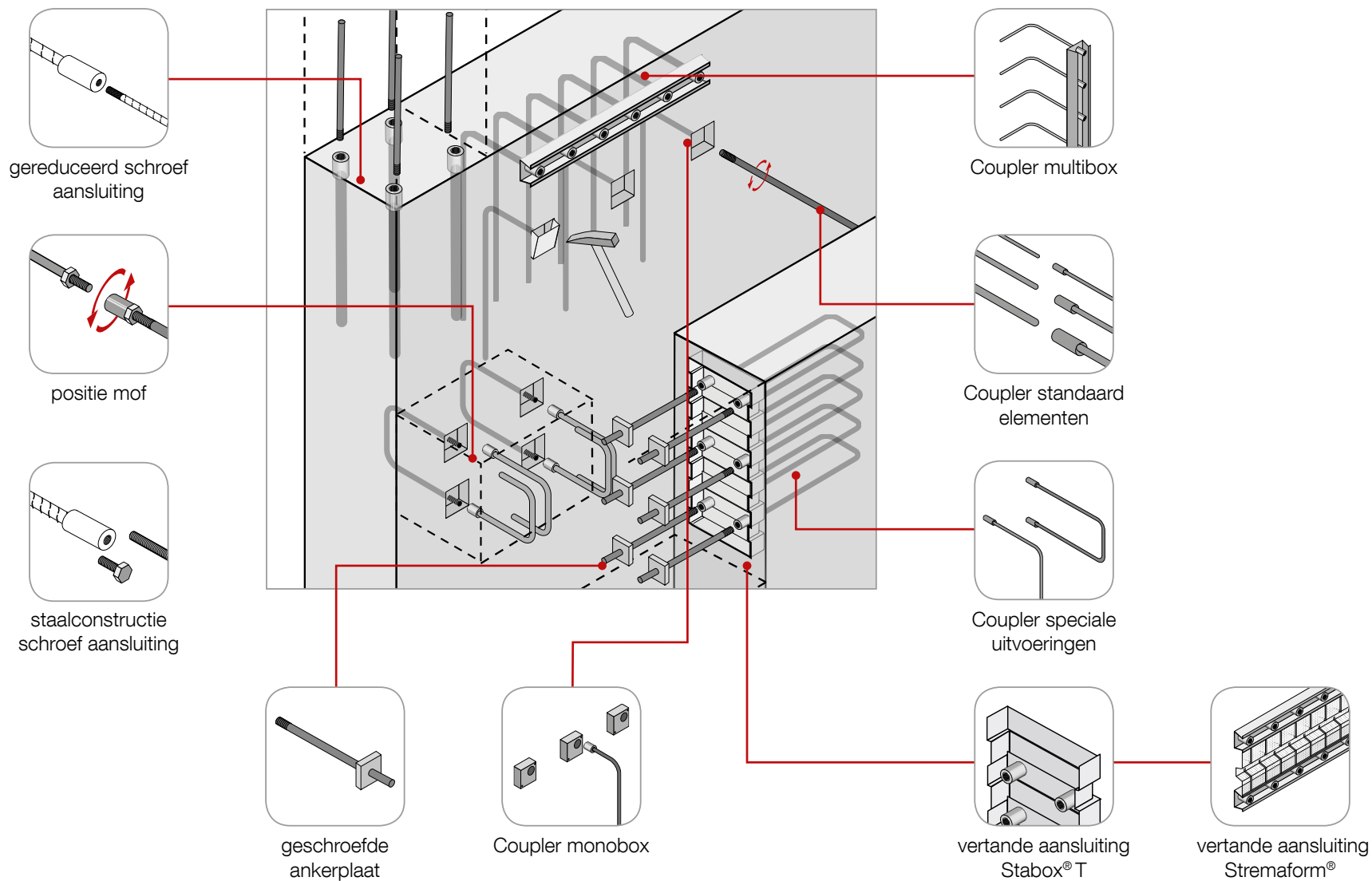

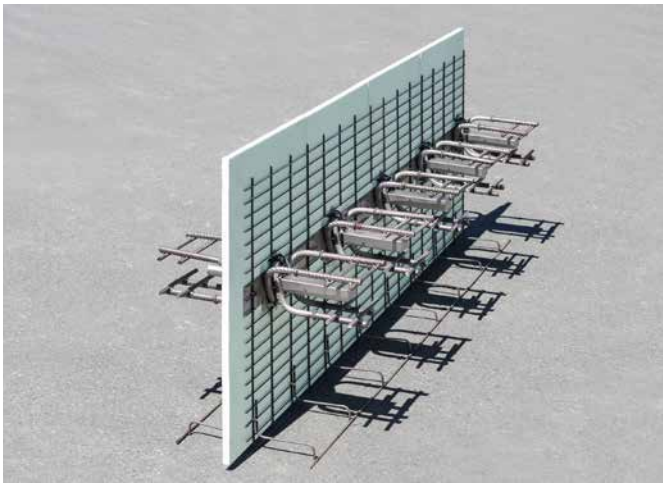
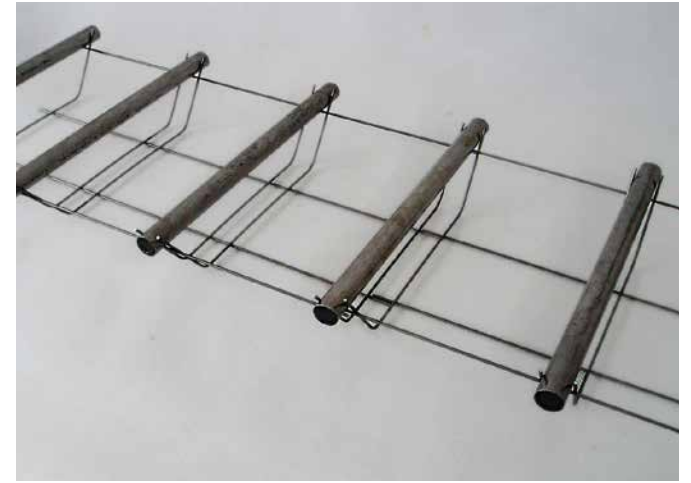
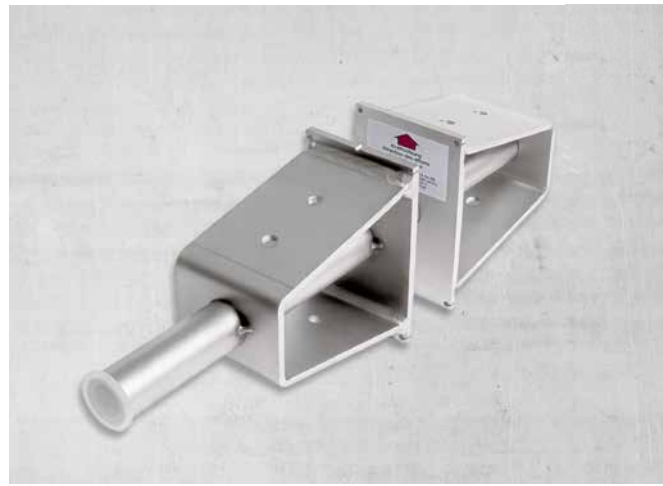
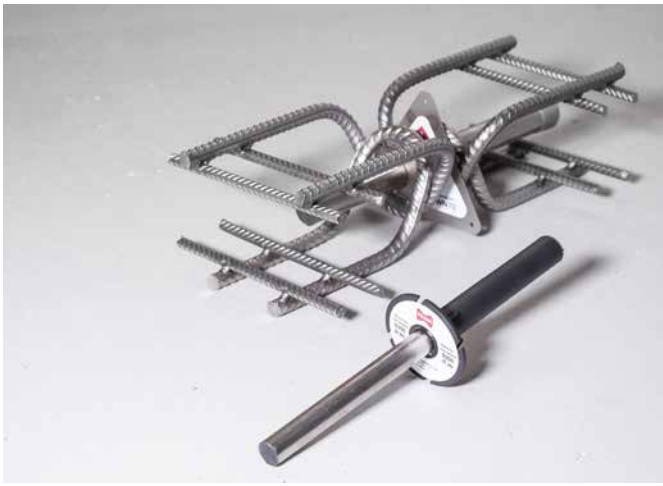

Egcodorn® deuvel systeem



Deuvels voor zware belastingen

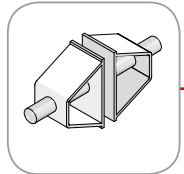

Egcodorn® DND

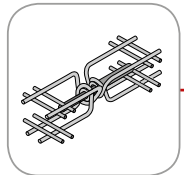

Egcodorn® WN



Egcodorn® WQ

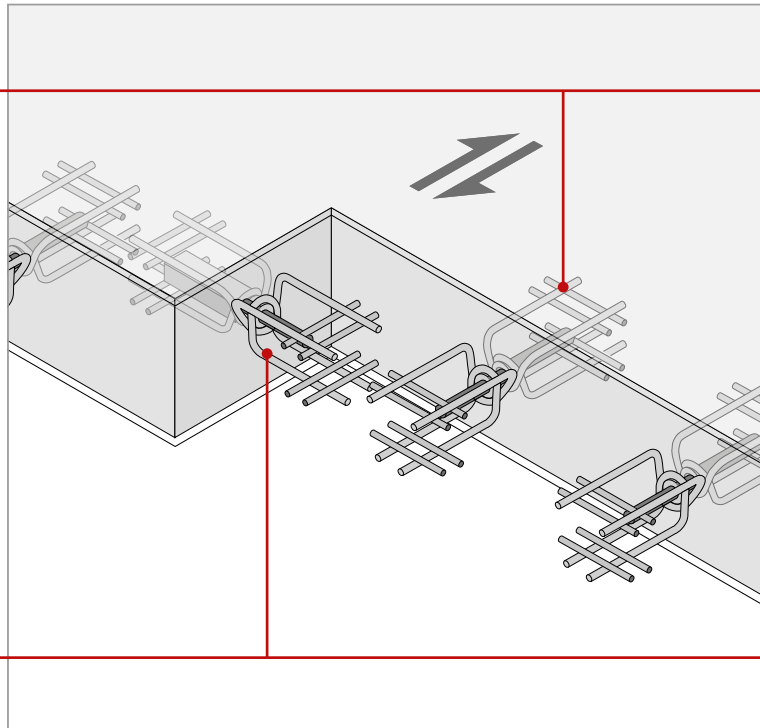

Deuvels met huls

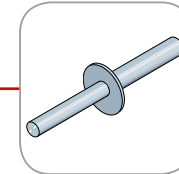

Egcodeuvel voor opname langs beweging

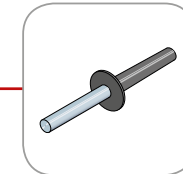

Egcodeuvel normaal met kunststofhuls

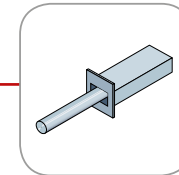

Egcodeuvel voor normaal en dwars beweging



brandwerende afdichting

Deuvels zonder huls



deuvel stiel

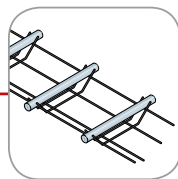

Egcodeuvel met rvs mantel

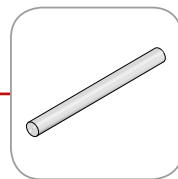

Egcodeuvel verzinkt

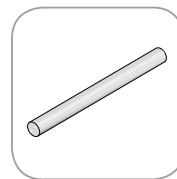

Egcodeuvel met coating

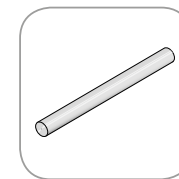

Egcodeuvel met halfzijdige coating

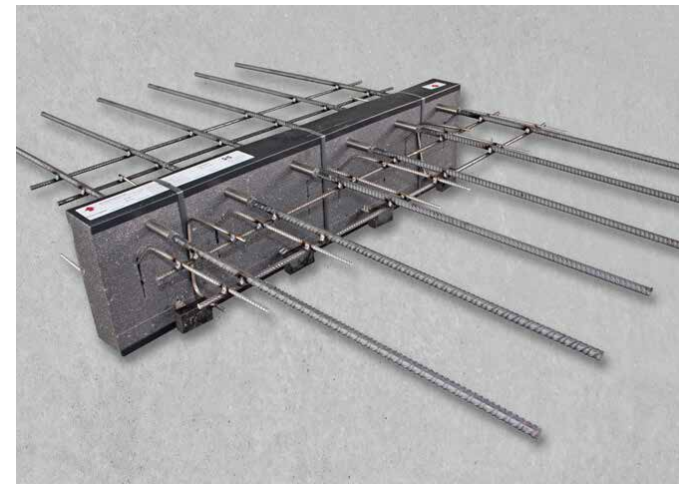

Egcoibox® koudebrug onderbreking

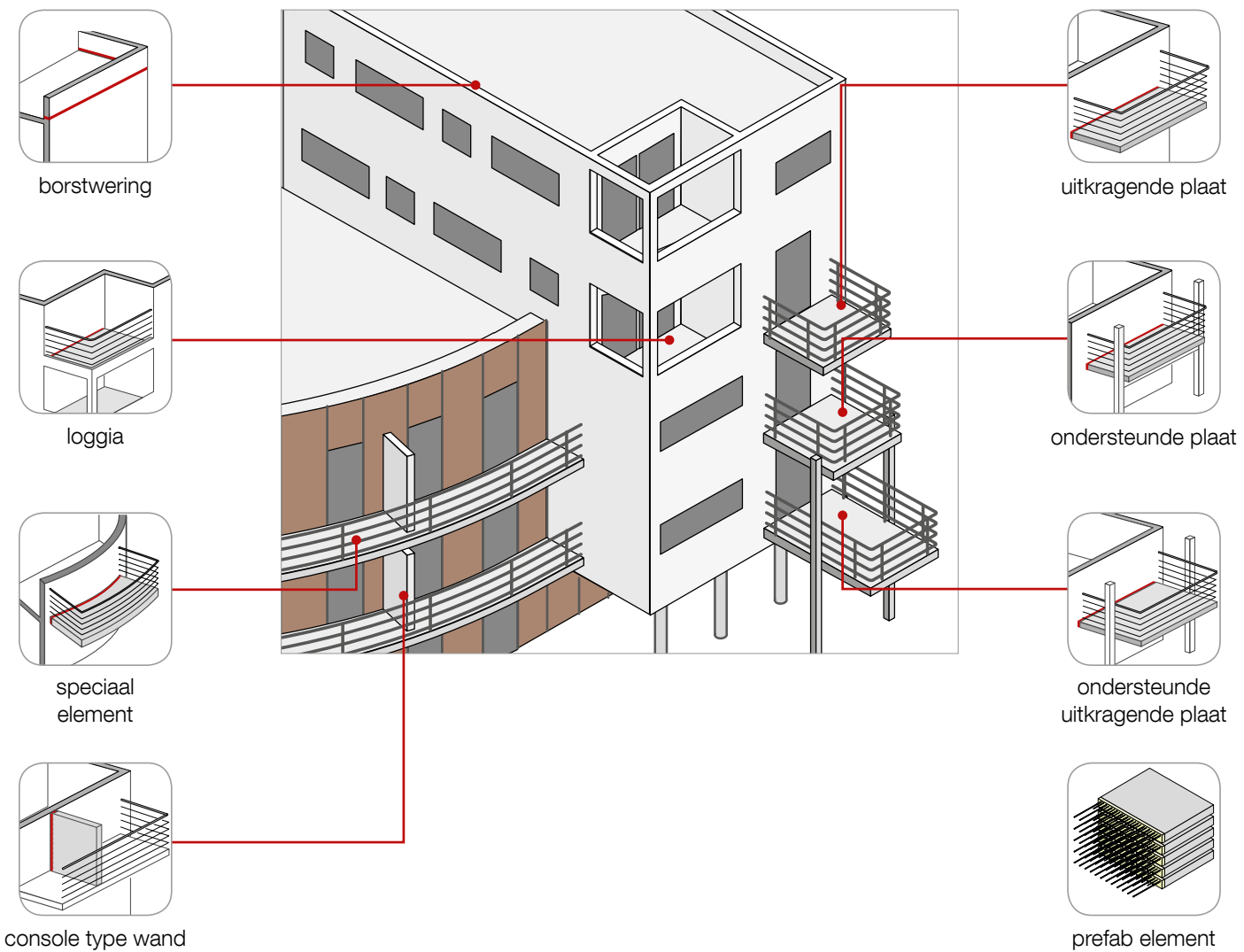

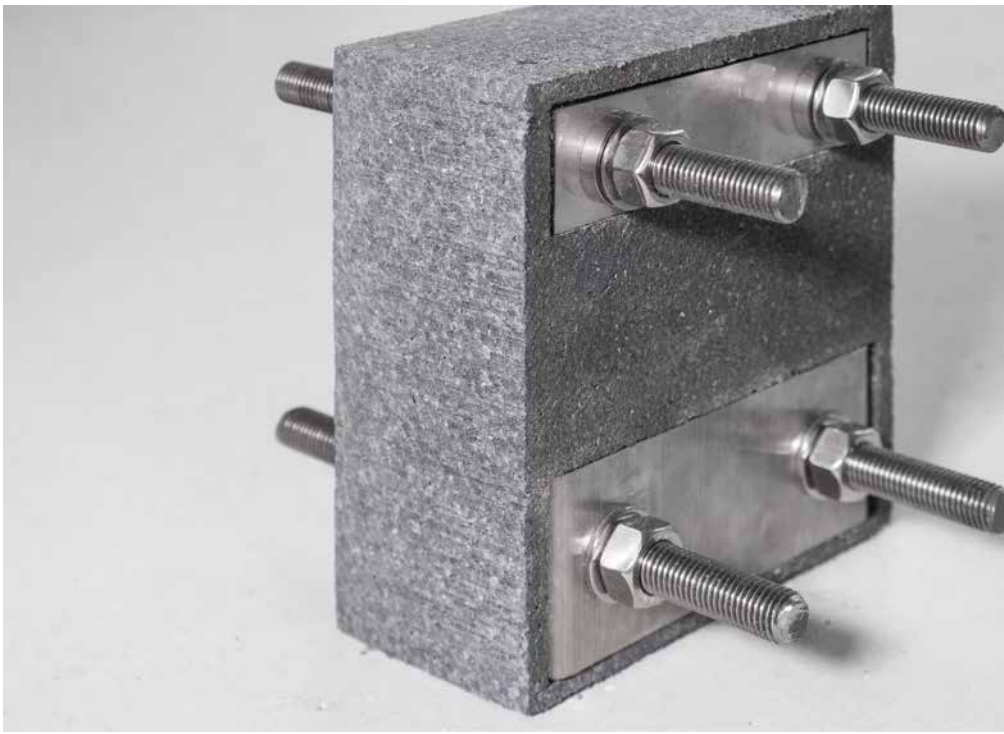

Staal aansluiting EgcoBox® FST

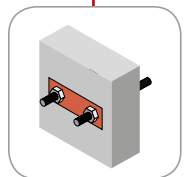
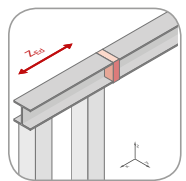
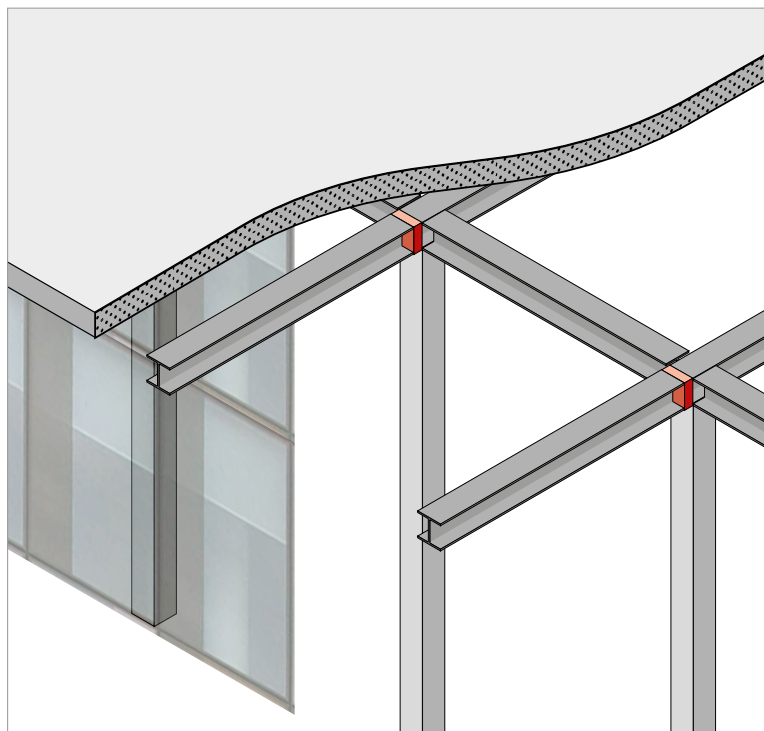

voor belasting op trek

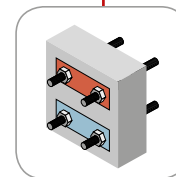
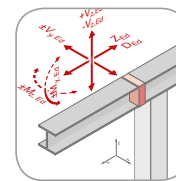

voor belasting met moment, normaal- en dwarskracht

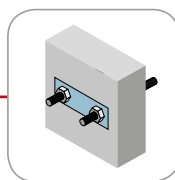
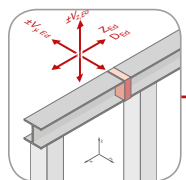

voor belasting op normaal- en dwarskracht

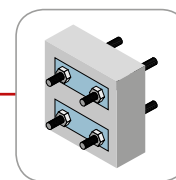
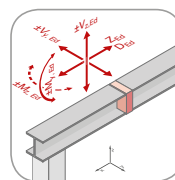

voor belasting met wisselende moment, normaal- en dwarskracht



Fradiflex® kimplaat

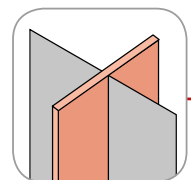

Fradiflex® scheur inleider

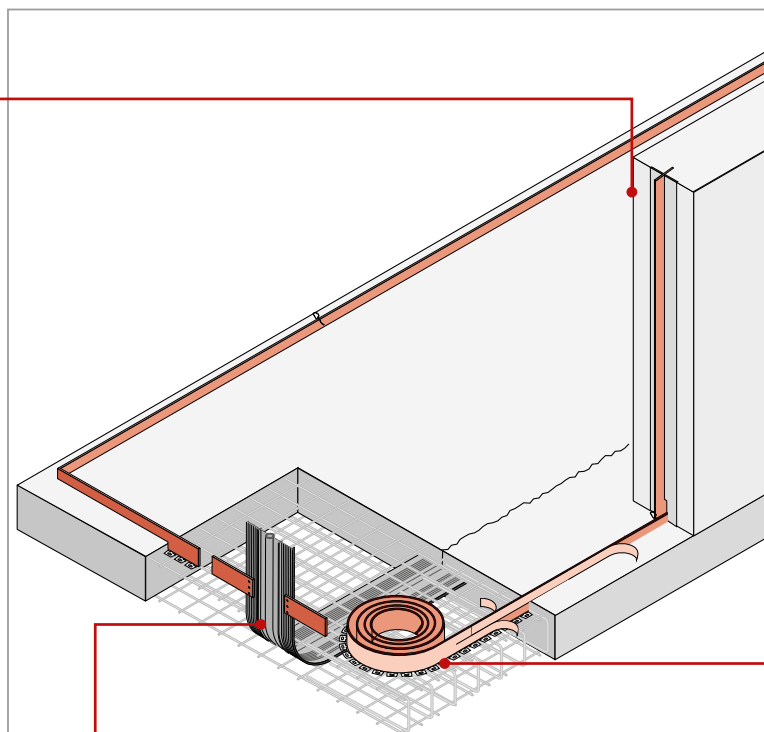

Fradiflex® rollen

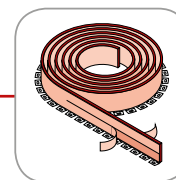

Premium:
dubbelzijdig gecoat

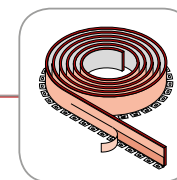

Standaard:
enkelzijdig gecoat

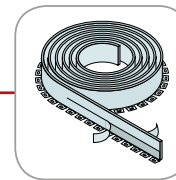

Premium RVS (316)

Fradiflex® platen

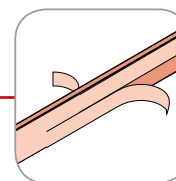

Premium:
dubbelzijdig gecoat

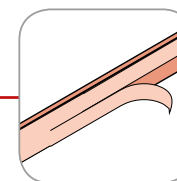

Standaard:
enkelzijdig gecoat

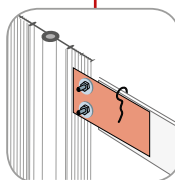

voegenband aansluiting

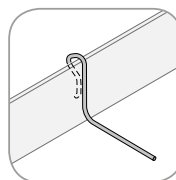

montage beugel

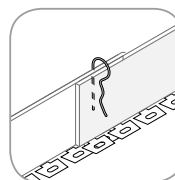

klembeugel

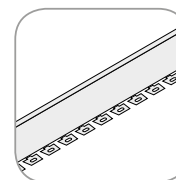

alle variaties van Fradiflex® zijn met of zonder montage hoek

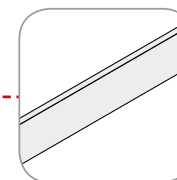

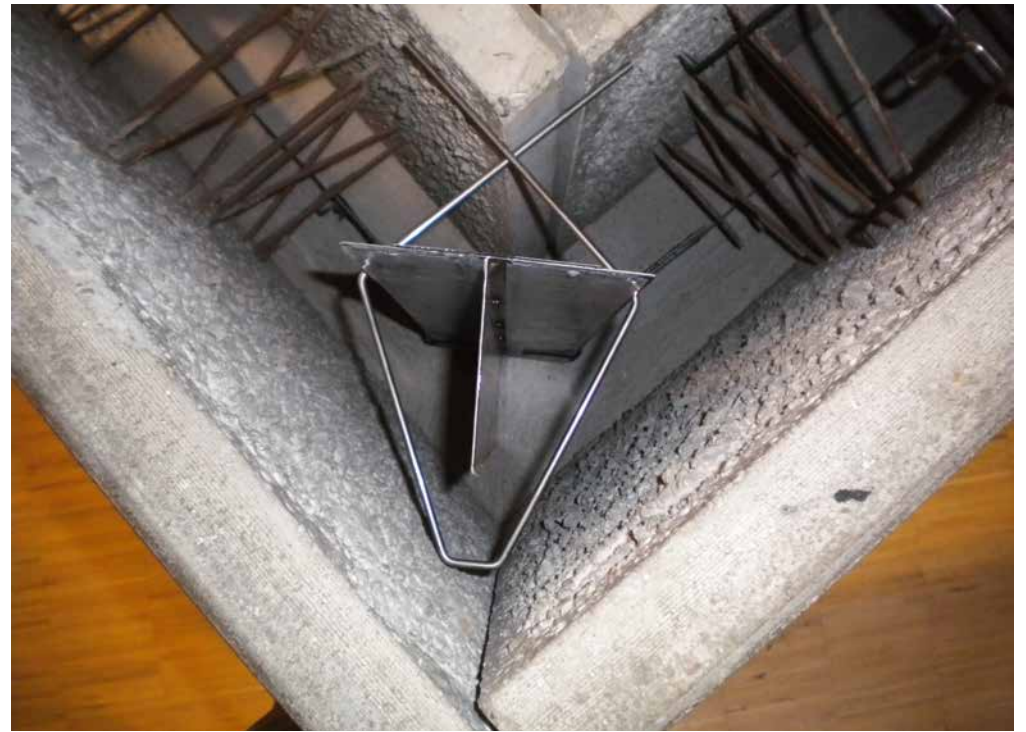
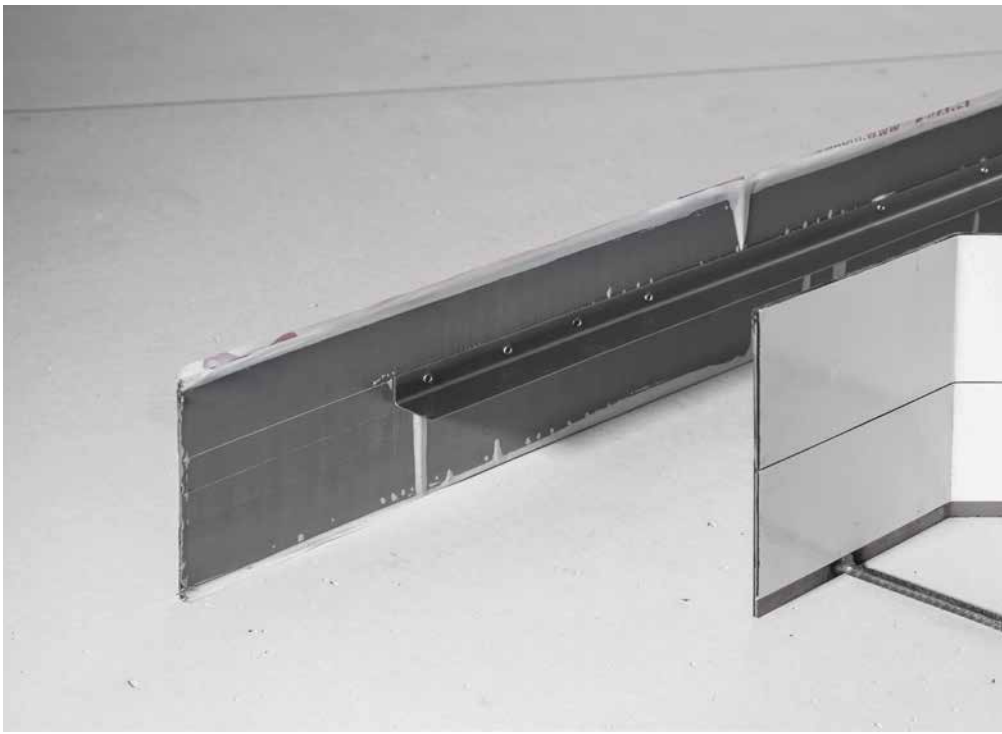

Fradiflex® voegblik wand element

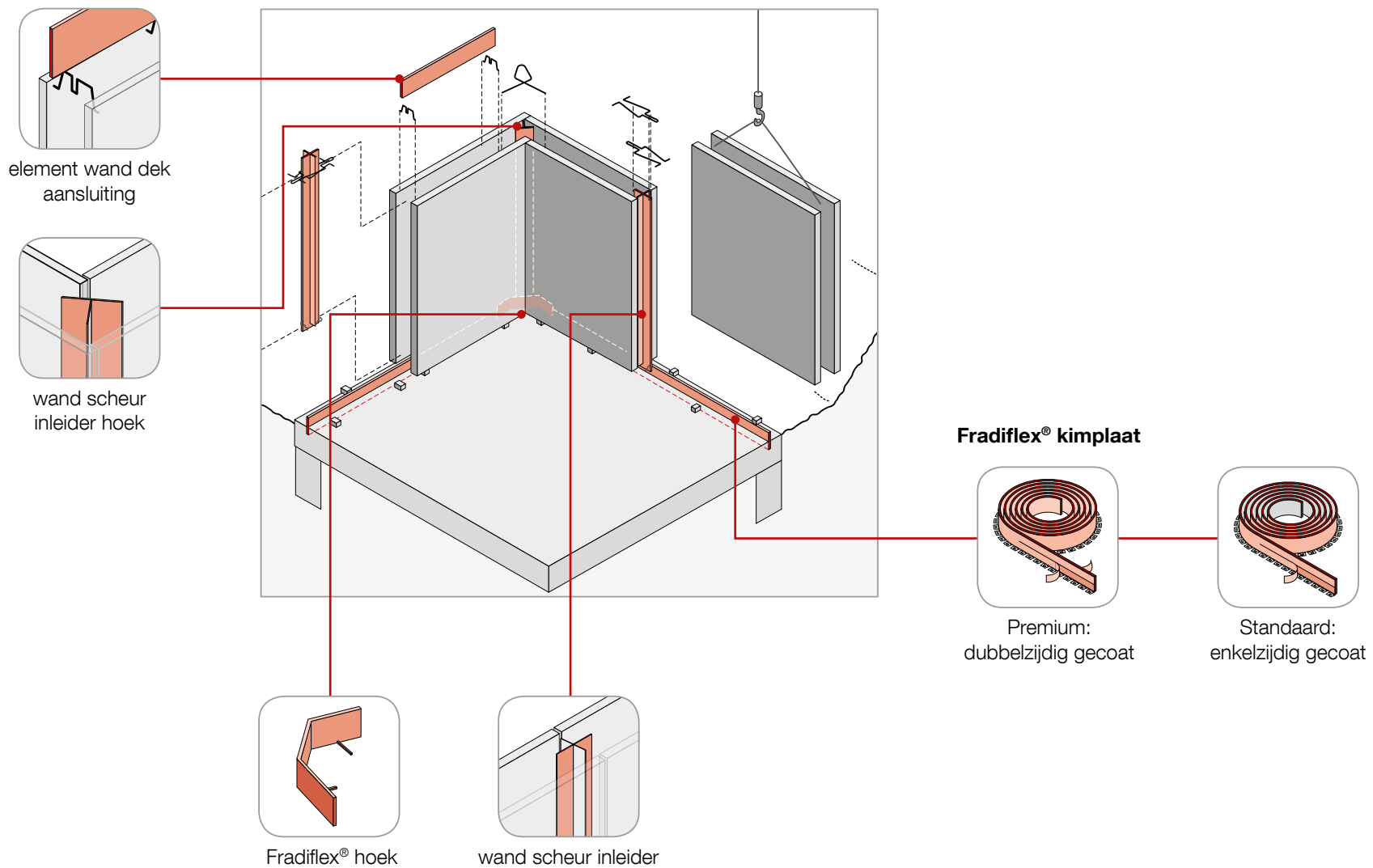

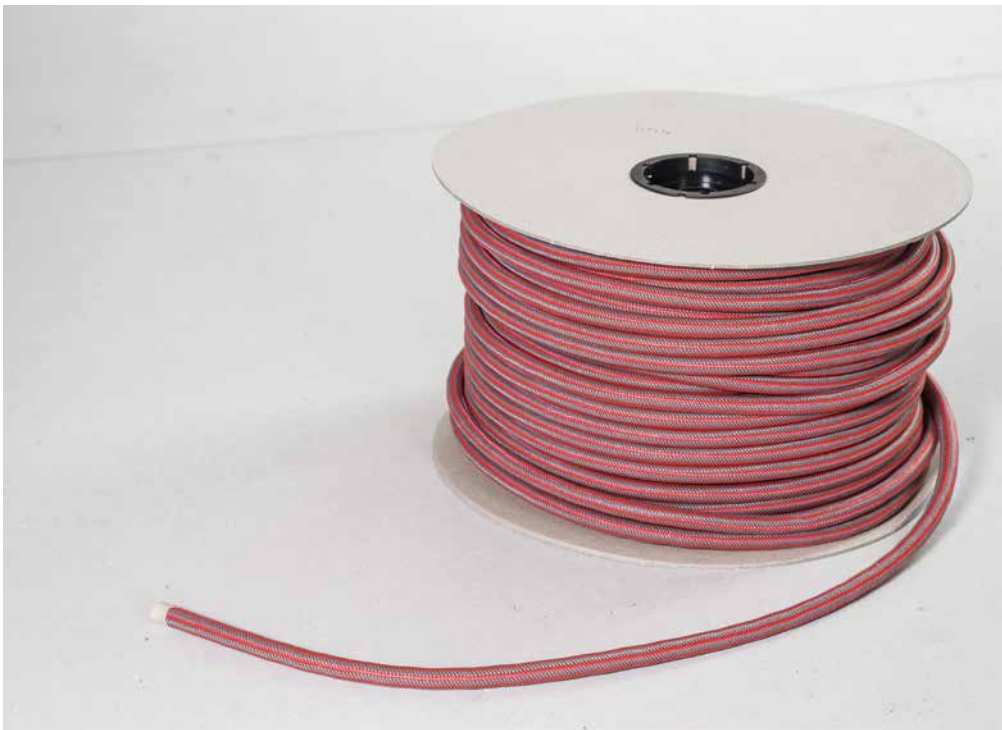

Intec® injectie systeem

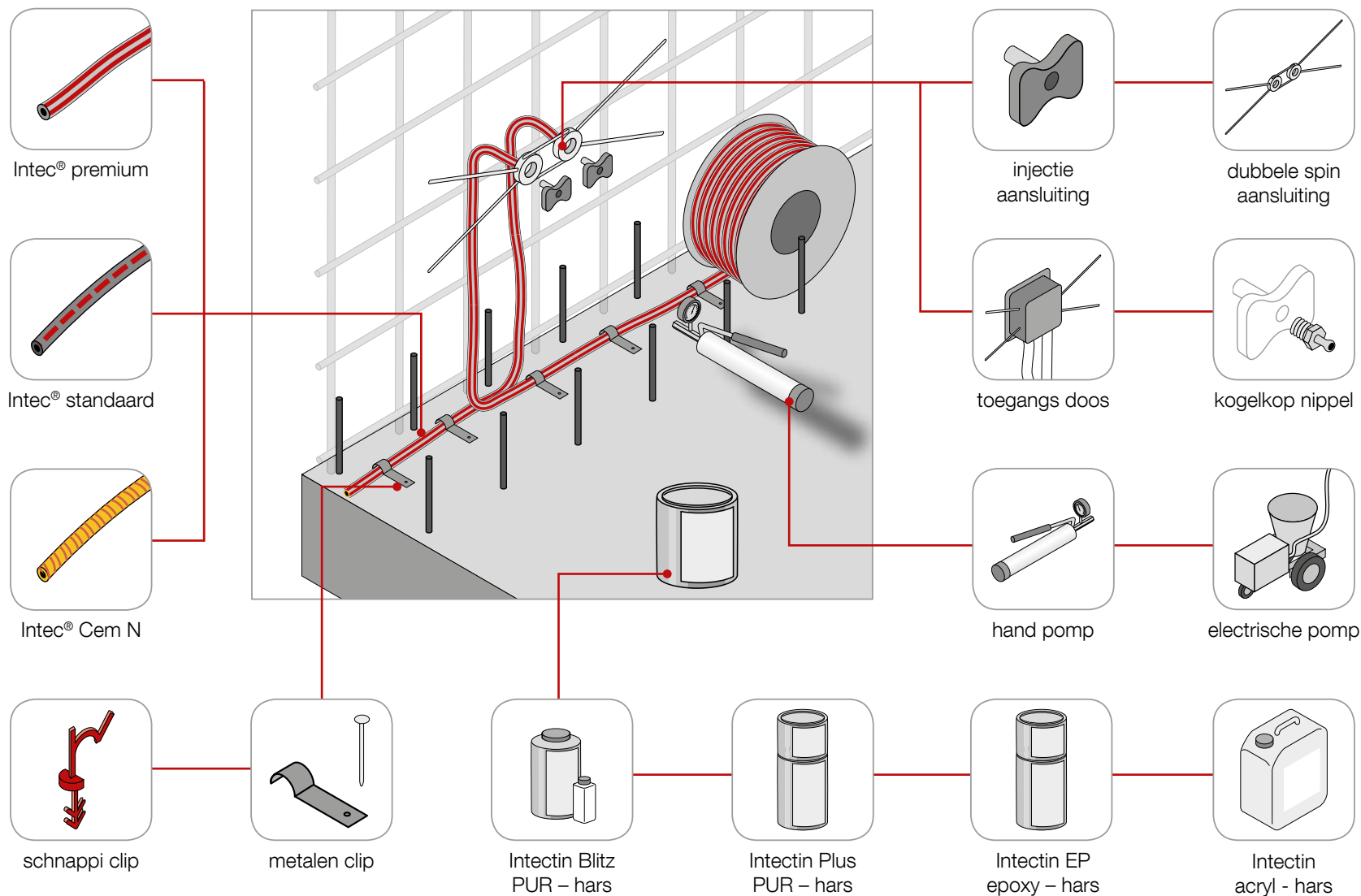



Intec[®] injectie materiaal

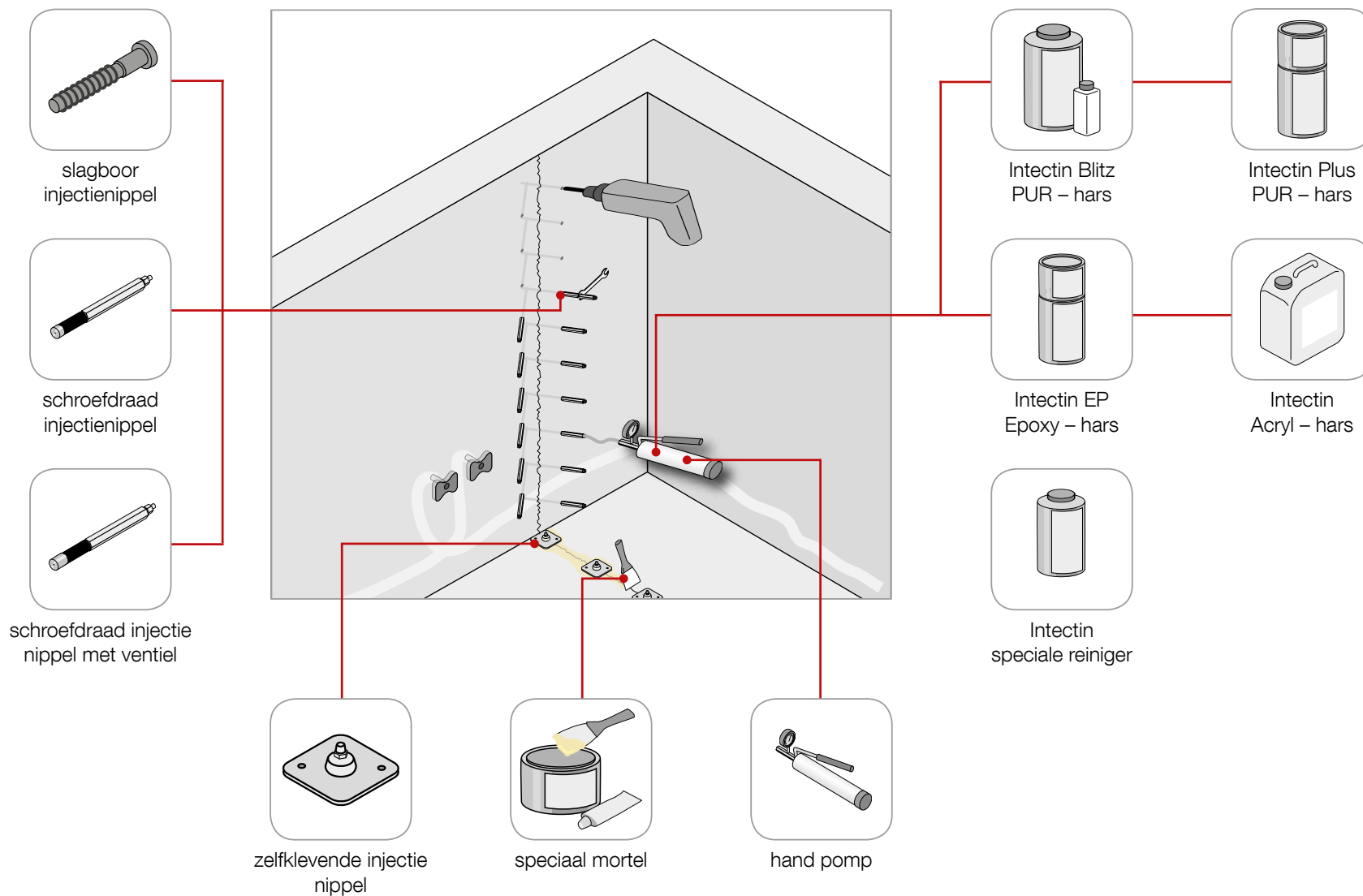

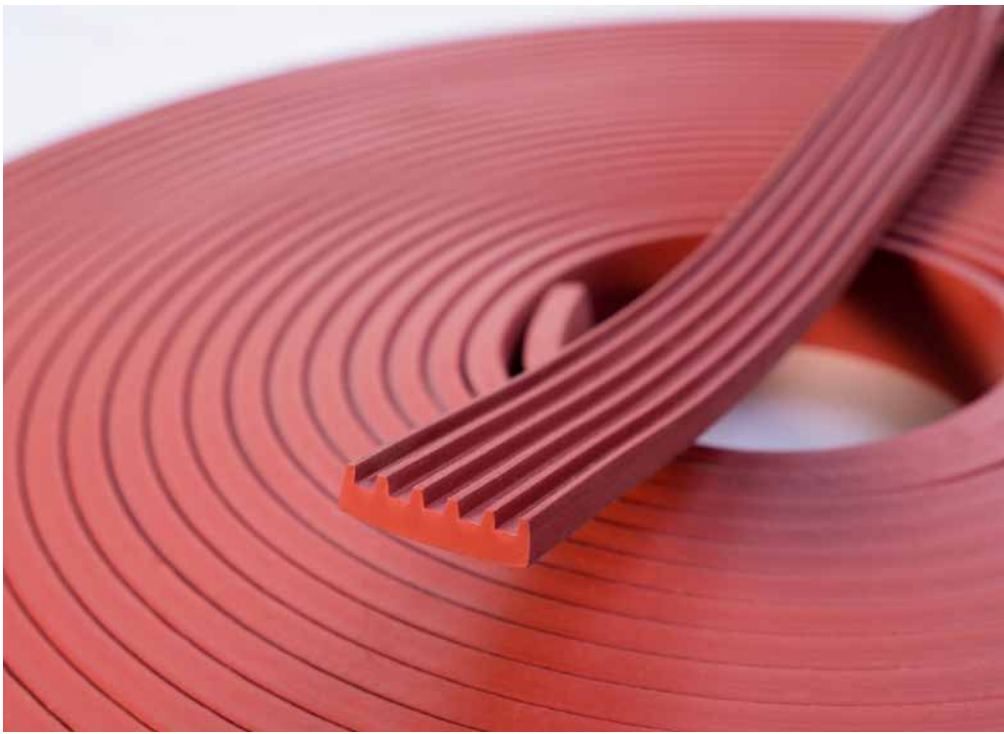

Cresco® zweiband

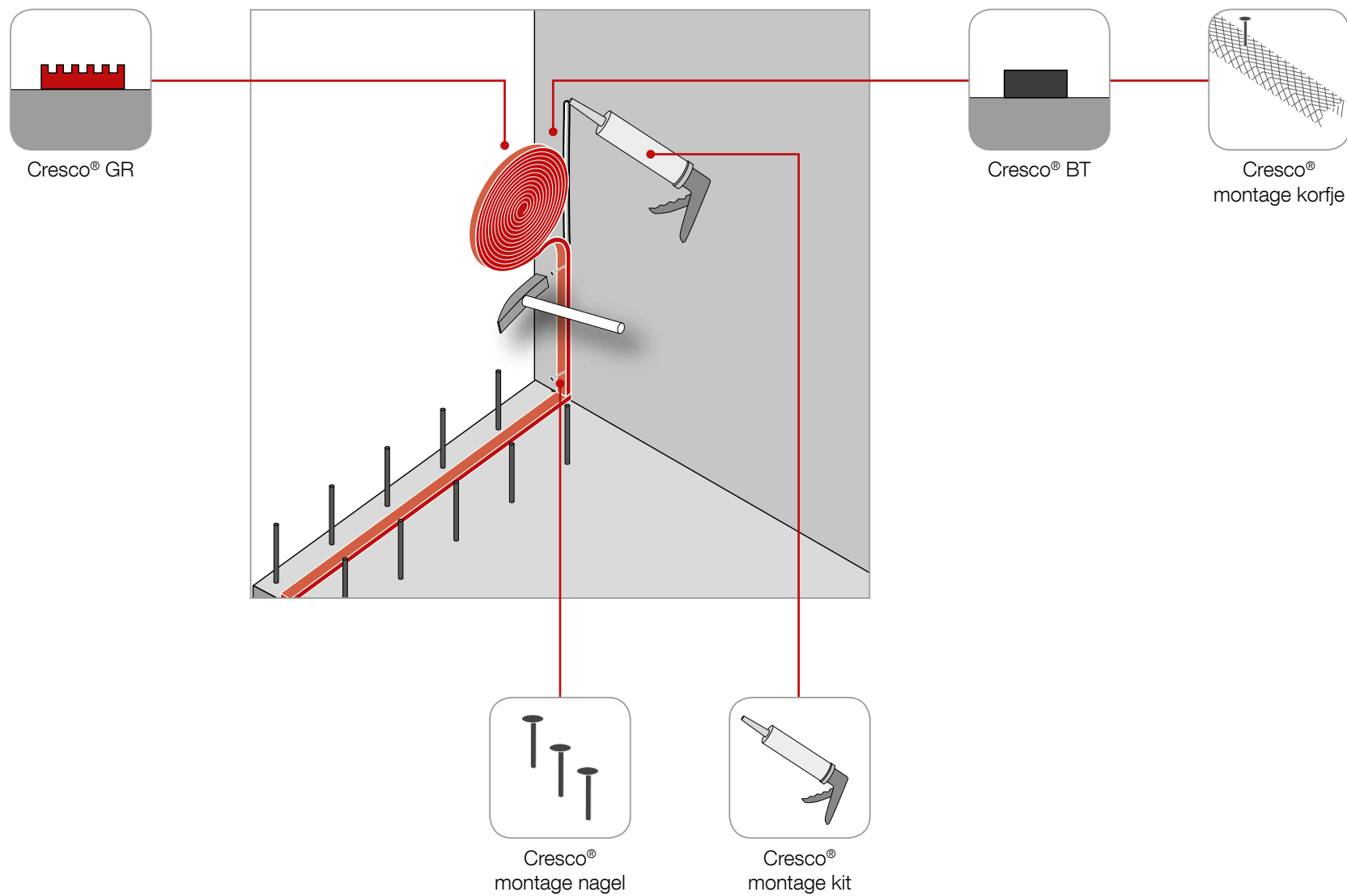



Permur® buis doorvoer

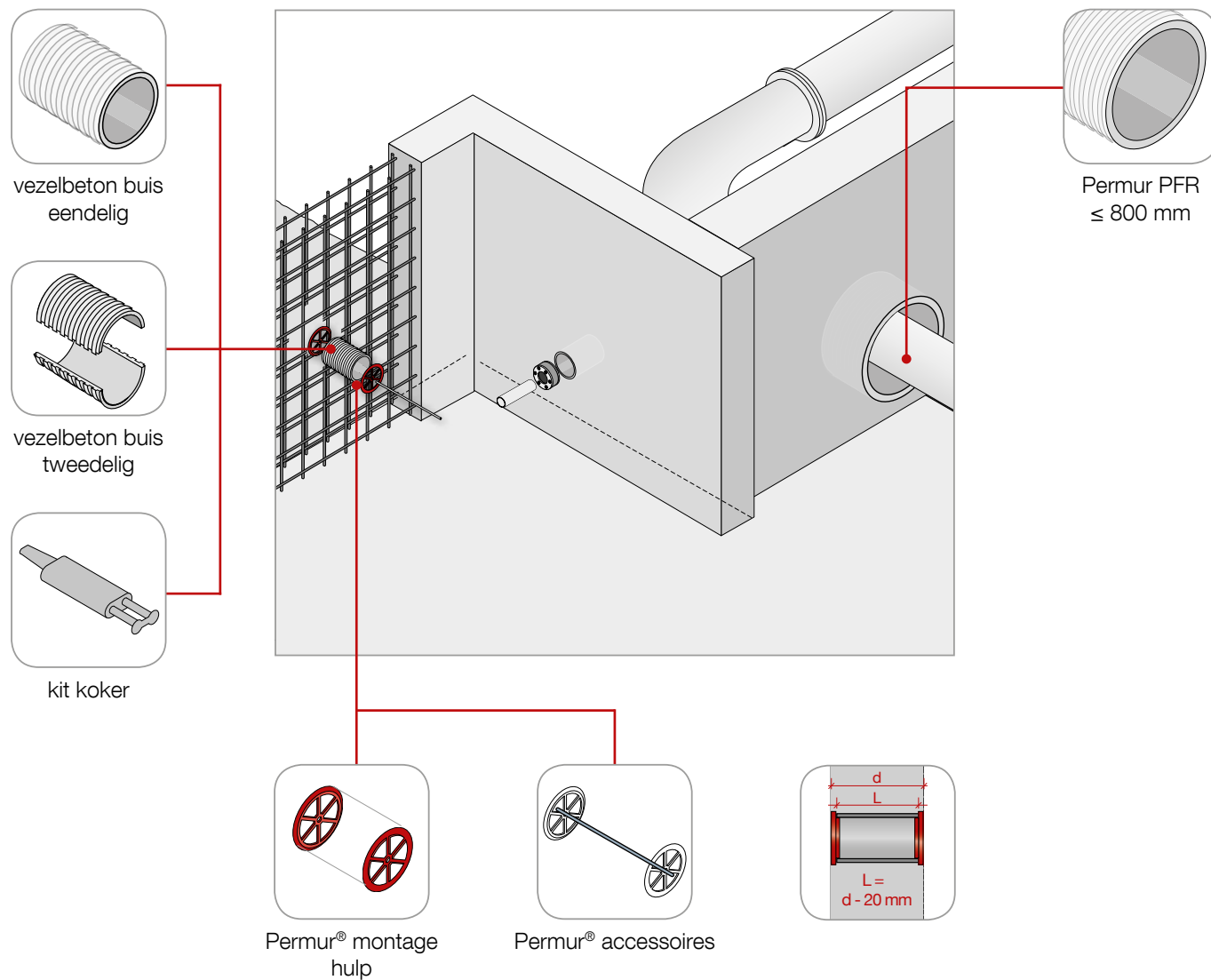

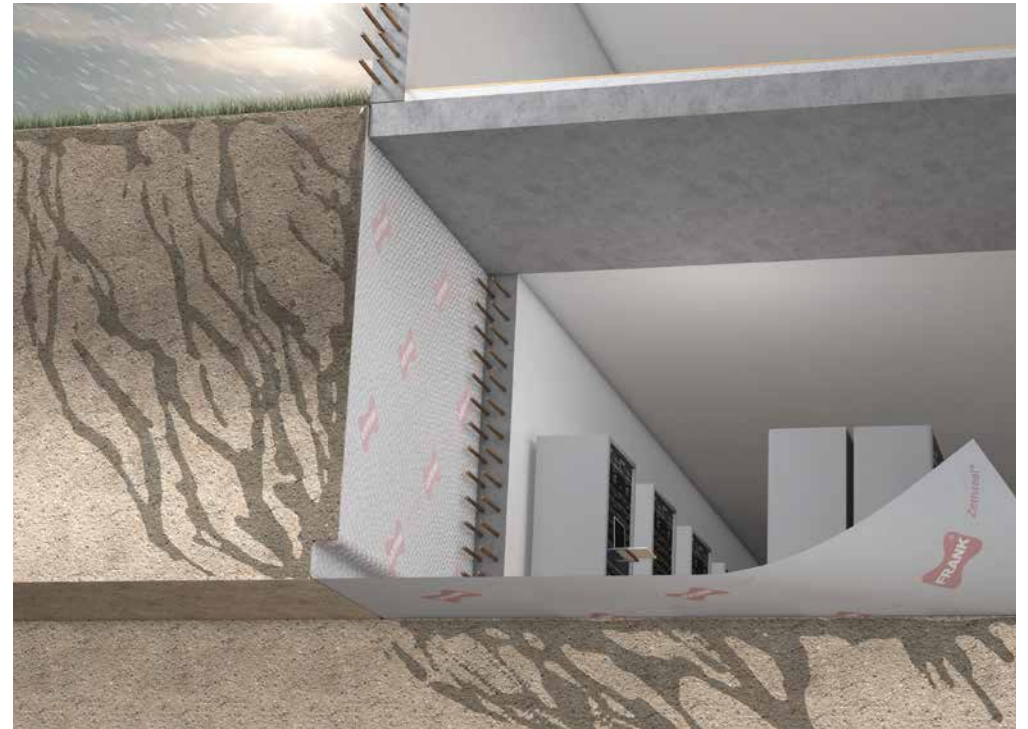

Zemseal® membraam voor verse beton

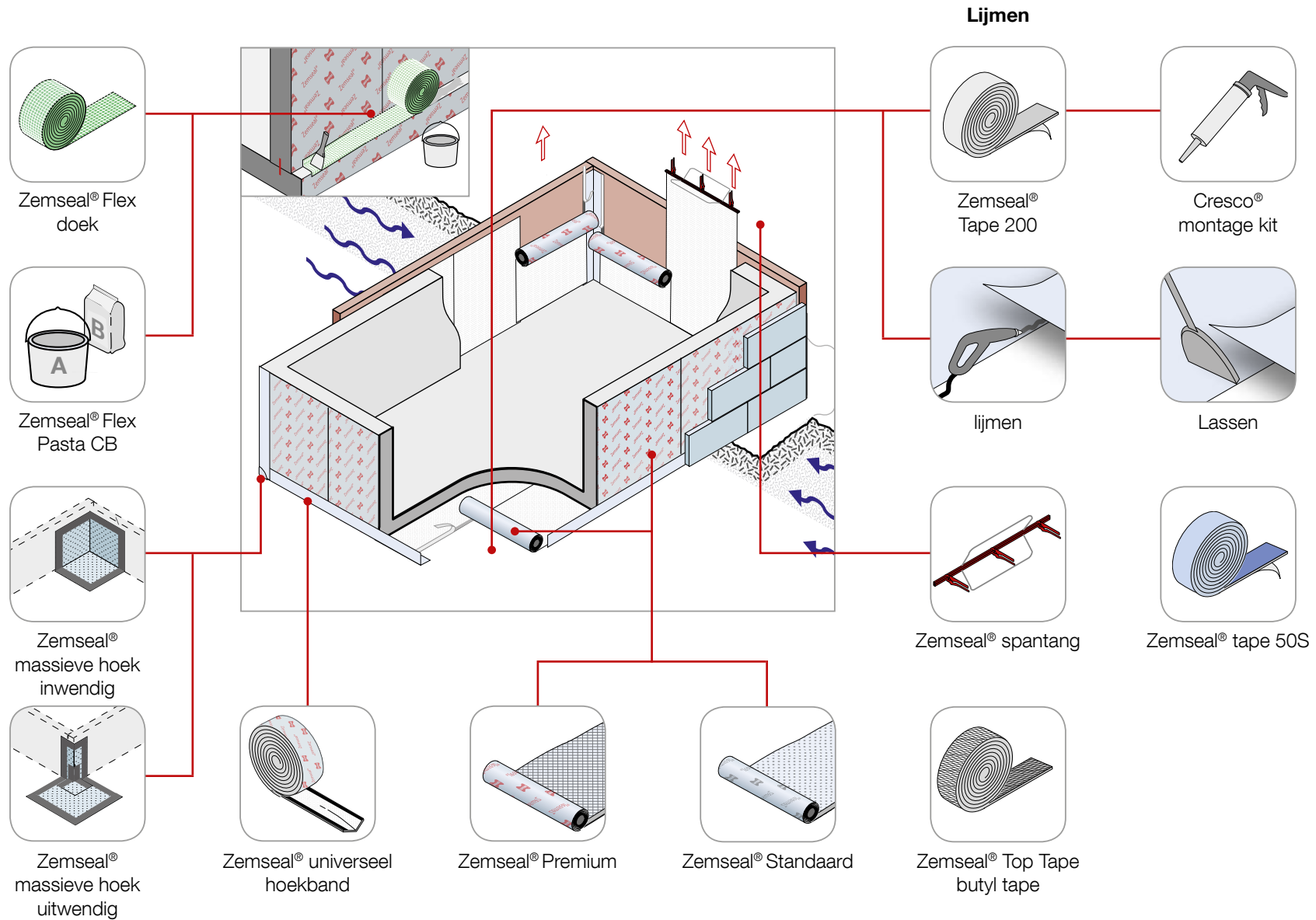

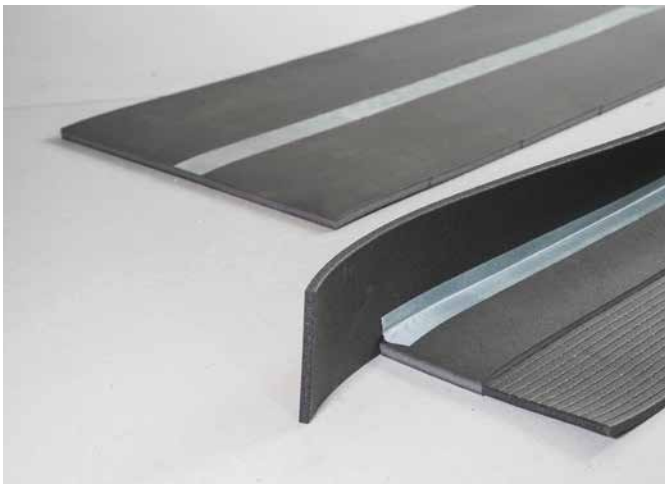

Trappen oplegging

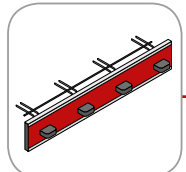

Egcostep® NG

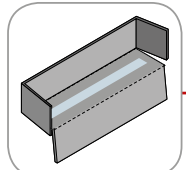

Egcoscal NG
form S

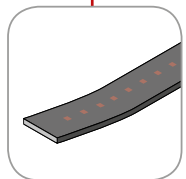

Egcoscal NG
form F

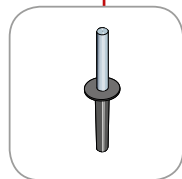
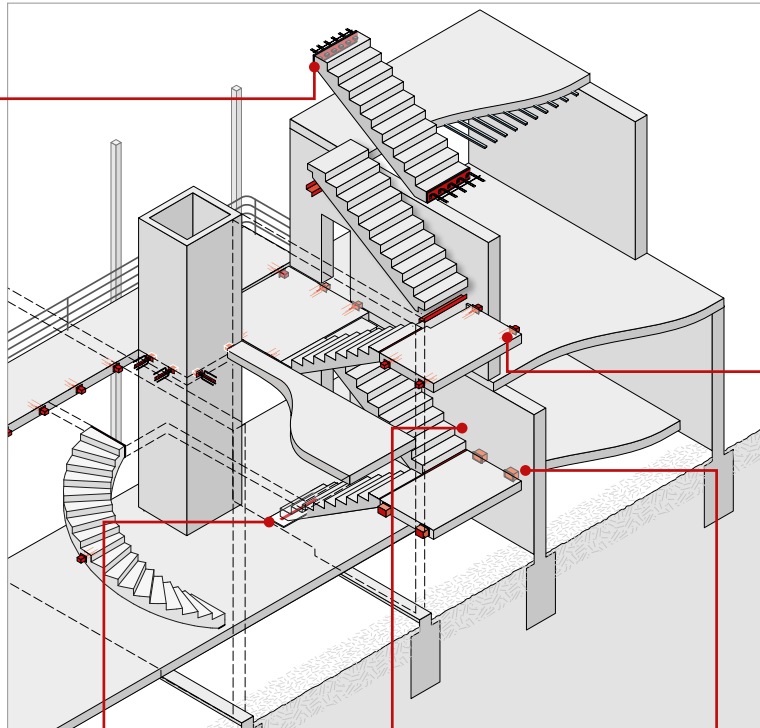

Egcoscal dook

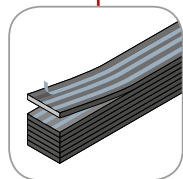

FDPL afstandhouder
plaat

Akoestisch ontkoppel systeem

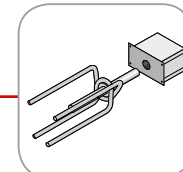

Egcotritt in situ
constructie

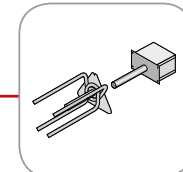

Egcotritt prefab
constructie

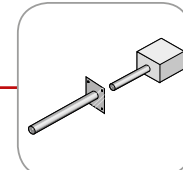

Egcotritt light

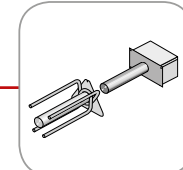

Egcotritt XL

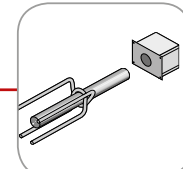

Egcotritt HL

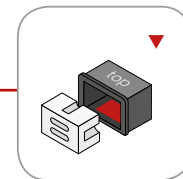

Egcosono P

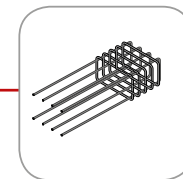

wapenings korf



Egcodist wand en vloer opleggingen

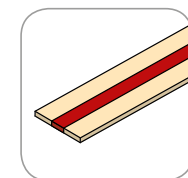
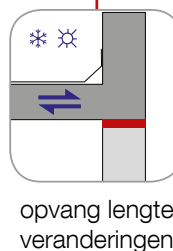
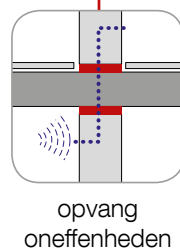
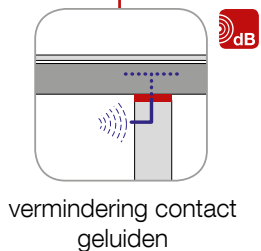
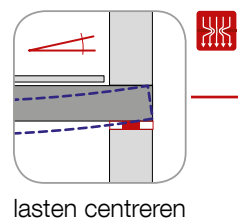
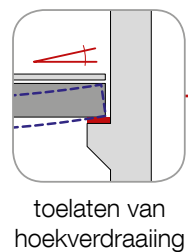
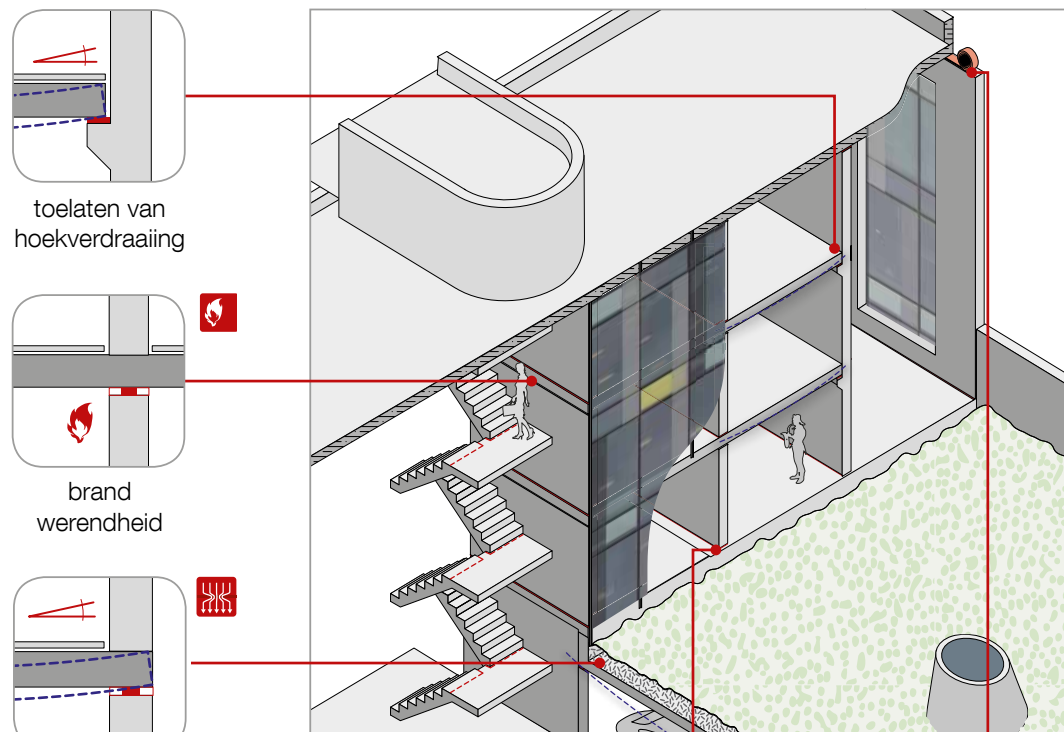

centreer oplegging R90

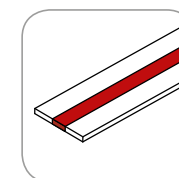

centreer oplegging

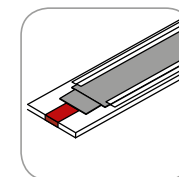

glij oplegging

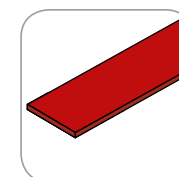

vervormbare oplegging

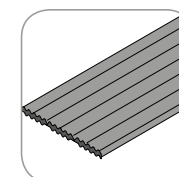

gegolfde oplegging



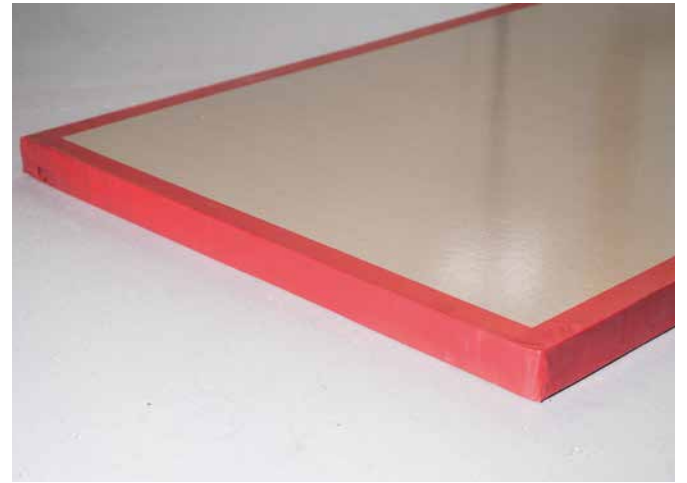

Egcovoid® zettingsplaat

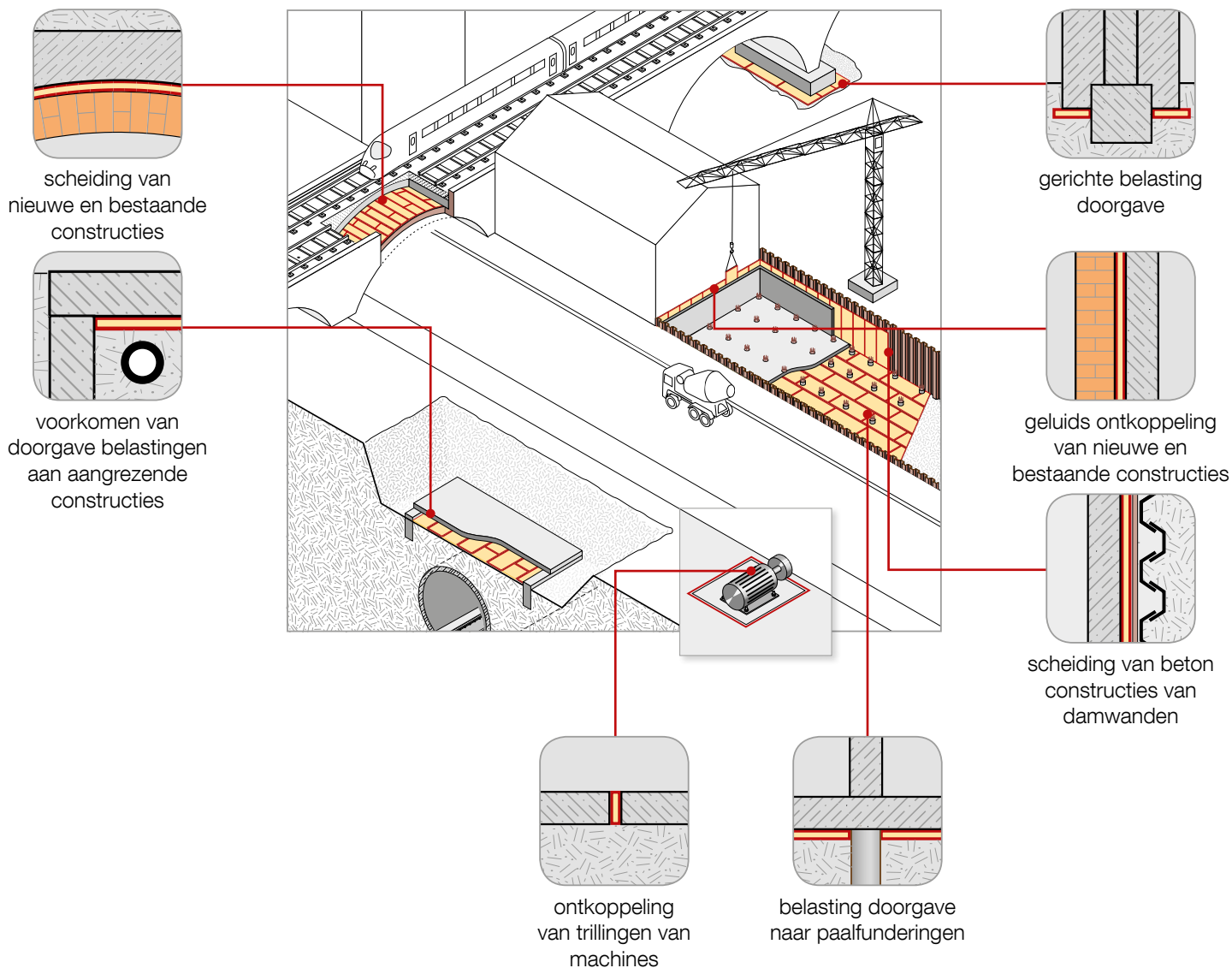

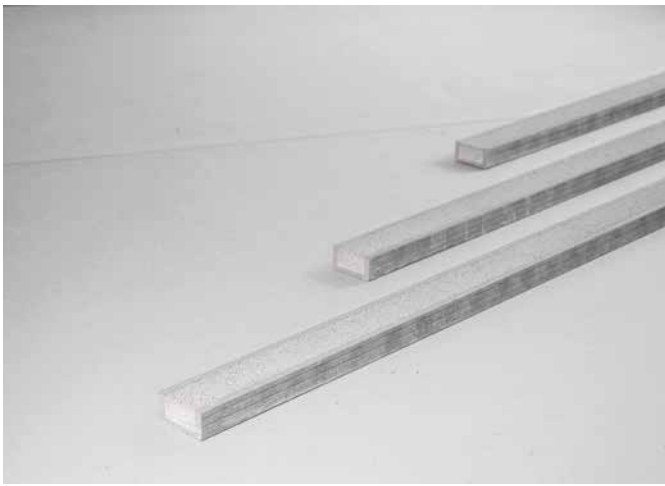

Sorp10[®] geluidsabsorbtie in combinatie met beton kernactivering

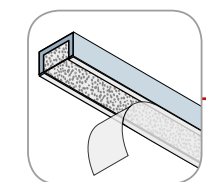

Sorp10[®]
monteren met tape

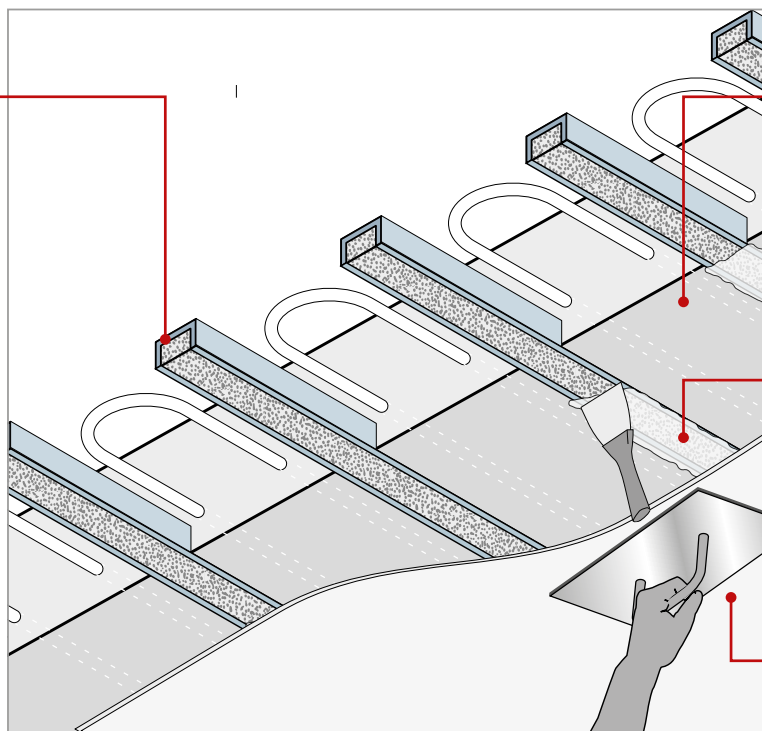

akoestische afwerk mortels

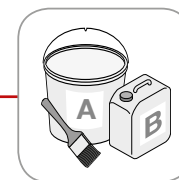

Sorp primer

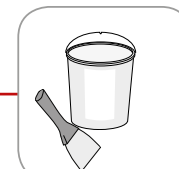

Sorp uitvul mortel

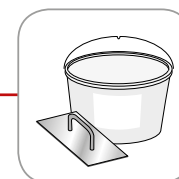

Sorp akoestische
stuc



Max Frank Nederland B.V.

Ramgatseweg 9a
4941 VN Raamsdonksveer
Netherlands

Tel. +31 162 241 051

info@maxfrank.nl
www.maxfrank.nl